

# TOSHIBA



## DVD VIDEO PLAYER SD-K710

*OWNER'S MANUAL*



Introduction 2

Connections 18

Basic playback 26

Advanced playback 34

Quick control 46

Function setup 56

Others 68



# SAFETY PRECAUTIONS

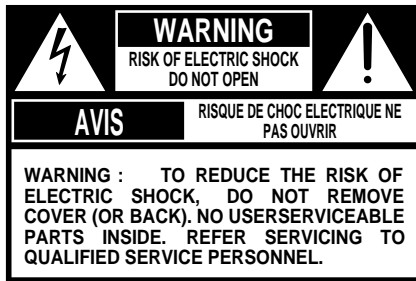

The lightning flash with arrowhead symbol, within an equilateral triangle, is intended to alert the user to the presence of uninsulated "dangerous voltage" within the product's enclosure that may be of sufficient magnitude to constitute a risk of electric shock to persons.



The exclamation point within an equilateral triangle is intended to alert the user to the presence of important operating and maintenance (servicing) instructions in the literature accompanying the appliance.



The symbol for CLASS II (Double Insulation)

**WARNING:** TO REDUCE THE RISK OF FIRE OR ELECTRIC SHOCK, DO NOT EXPOSE THIS APPLIANCE TO RAIN OR MOISTURE. DANGEROUS HIGH VOLTAGES ARE PRESENT INSIDE THE ENCLOSURE. DO NOT OPEN THE CABINET. REFER SERVICING TO QUALIFIED PERSONNEL ONLY.

**CAUTION:** TO PREVENT ELECTRIC SHOCK, MATCH WIDE BLADE OF PLUG TO WIDE SLOT, FULLY INSERT.

**ATTENTION:** POUR EVITER LES CHOCES ELECTRIQUES, INTRODUIRE LA LAME LA PLUS LARGE DE LA FICHE DANS LA BORNE CORRESPONDANTE DE LA PRISE ET POUSSER JUSQU'AU FOND.

**CAUTION:** This Digital Video Disc Player employs a Laser System. To ensure proper use of this product, please read this owner's manual carefully and retain for future reference. Should the unit require maintenance, contact an authorized service location - see service procedure.

Use of controls or adjustments or performance of procedures other than those specified herein may result in hazardous radiation exposure.

To prevent direct exposure to laser beam, do not try to open the enclosure. Visible and invisible laser radiation when open and interlocks defeated. DO NOT STARE INTO BEAM.

**FCC NOTICE:** This equipment has been tested and found to comply with the limits for a Class B digital device, pursuant to part 15 of the FCC Rule. These limits are designed to provide reasonable protection against harmful interference in a residential installation.

This equipment generates, uses, and can radiate radio frequency energy and, if not installed and used in accordance with the instructions, may cause harmful interference to radio communications.

However, there is no guarantee that interference will not occur in a particular installation. If this equipment does cause harmful interference to radio or television reception, which can be determined by turning the equipment off and on, the user is encouraged to try to correct the interference by one or more of the following measures:

- Reorient or relocate the receiving antenna.
- Increase the separation between the equipment and receiver.
- Connect the equipment into an outlet on a circuit different from that to which the receiver is connected.
- Consult the dealer or an experienced radio/TV technician for help.

**WARNING:** Changes or modifications made to this equipment, not expressly approved by Toshiba, or parties authorized by Toshiba, could void the user's authority to operate the equipment.

The instructions shall state that an ALL-POLE MAINS SWITCH with a contact separation of at least 3 mm in each pole shall be incorporated in the electrical installation of the building.

**CAUTION:** These servicing instructions are for use by qualified service personnel only. To reduce the risk of electric shock do not perform any servicing other than that contained in the operating instructions unless you are qualified to do so.

In the spaces provided below, record the Model and Serial No. located on the rear panel of your DVD player.

Model No. \_\_\_\_\_

Serial No. \_\_\_\_\_

Retain this information for future reference.

**Location of the required label**

---

PRODUCT IS CERTIFIED BY THE MANUFACTURER TO COMPLY WITH DHHS RULE 21 CFR SUBCHAPTER J APPLICABLE AT THE DATE OF MANUFACTURE.

MANUFACTURED

**TOSHIBA CORPORATION**  
1-1, SHIBAURA 1-CHOME, MINATO-KU.  
TOKYO 105-8001, JAPAN

---

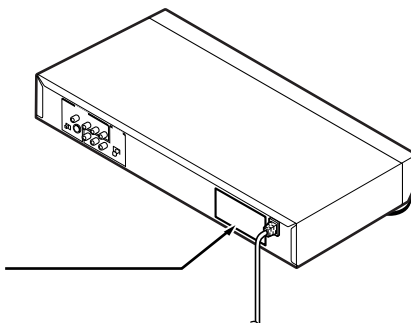

# IMPORTANT SAFETY INSTRUCTIONS

**CAUTION: PLEASE READ AND OBSERVE ALL WARNINGS AND INSTRUCTIONS GIVEN IN THIS OWNER'S MANUAL AND THOSE MARKED ON THE UNIT. RETAIN THIS BOOKLET FOR FUTURE REFERENCE.**

This set has been designed and manufactured to assure personal safety. Improper use can result in electric shock or fire hazard. The safeguards incorporated in this unit will protect you if you observe the following procedures for installation, use and servicing. This unit is fully transistorized and does not contain any parts that can be repaired by the user.

**DO NOT REMOVE THE CABINET COVER, OR YOU MAY BE EXPOSED TO DANGEROUS VOLTAGE. REFER SERVICING TO QUALIFIED SERVICE PERSONNEL ONLY.**

1. Read these instructions.

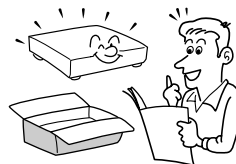

2. Keep these instructions.

3. Heed all warnings.

4. Follow all instructions.

5. Do not use this apparatus near water.

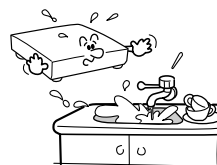

6. Clean only with dry cloth.



7. Do not block any ventilation openings. Install in accordance with the manufacturer's instructions.



8. Do not install near any heat sources such as radiators, heat registers, stoves, or other apparatus (including amplifiers) that produce heat.

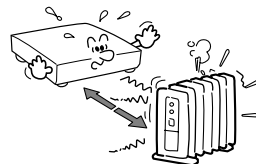

9. Do not defeat the safety purpose of the polarized or grounding-type plug. A polarized plug has two blades with one wider than the other. A grounding type plug has two blades and a third grounding prong. The wide blade or the third prong are provided for your safety. If the provided plug does not fit into your outlet, consult an electrician for replacement of the obsolete outlet.

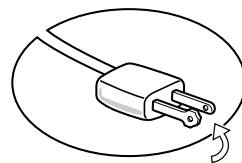

10. Protect the power cord from being walked on or pinched particularly at plugs, convenience receptacles, and the point where they exit from the apparatus.



11. Only use attachments/accessories specified by the manufacturer.

12. Use only with the cart, stand, tripod, bracket, or table specified by the manufacturer, or sold with the apparatus. When a cart is used, use caution when moving the cart/apparatus combination to avoid injury from tip-over.



# IMPORTANT SAFETY INSTRUCTIONS

13. Unplug this apparatus during lightning storms or when unused for long periods of time.

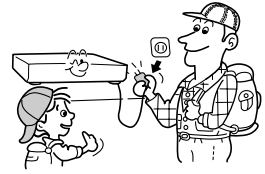

14. Refer all servicing to qualified service personnel. Servicing is required when the apparatus has been damaged in any way, such as power-supply cord or plug is damaged, liquid has been spilled or objects have fallen into the apparatus, the apparatus has been exposed to rain or moisture, does not operate normally, or has been dropped.

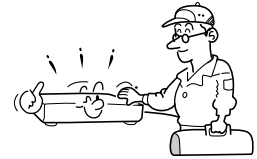

15. When you use headphones, keep the volume at a moderate level. If you use the headphones continuously with high volume sound, it may cause hearing damage.



16. Do not overload wall outlets; extension cords, or integral convenience receptacles as this can result in a risk of fire or electric shock.

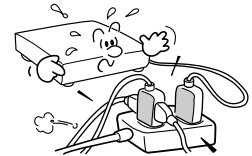

17. Never insert objects of any kind into this apparatus through openings as they may touch dangerous voltage points or short-out parts that could result in a fire or electric shock. Never spill liquid of any kind on the apparatus.



18. Keep your fingers well clear of the disc tray as it is closing. Neglecting to do so may cause serious personal injury.

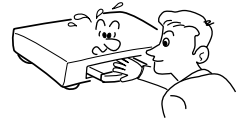

19. Do not place a heavy object on or step on the apparatus. The object may fall, causing serious personal injury and serious damage to the apparatus.

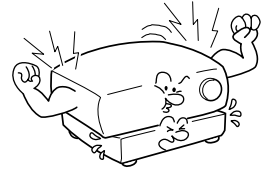

20. Do not use a cracked, deformed, or repaired disc. These discs are easily broken and may cause serious personal injury and apparatus malfunction.

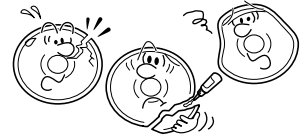

## Precautions

### Notes on handling

- When shipping the DVD player, the original shipping carton and packing materials come in handy. For maximum protection, repack the unit as it was originally packed at the factory.
- Do not use volatile liquids, such as insect spray, near the DVD player. Do not leave rubber or plastic products in contact with the DVD player for a long time. They will leave marks on the finish.
- The top and rear panels of the DVD player may become warm after a long period of use. This is not a malfunction.
- When the DVD player is not in use, be sure to remove the disc and turn off the power.
- If you do not use the DVD player for a long period, the unit may not function properly in the future. Turn on and use the DVD player occasionally.

### Notes on locating

- Place the DVD player on a level surface. Do not use it on a shaky or unstable surface such as a wobbling table or inclined stand. The loaded disc may come off the proper position and cause damage to the DVD player.
- When you place this DVD player near a TV, radio, or VCR, the playback picture may become poor and the sound may be distorted. In this case, place the DVD player away from the TV, radio, or VCR.

### Notes on cleaning

Use a soft, dry cloth for cleaning.

- For stubborn dirt, soak the cloth in a weak detergent solution, wring well and wipe. Use a dry cloth to wipe it dry.  
Do not use any type of solvent, such as thinner and benzene, as they may damage the surface of the DVD player.
- If you use a chemical saturated cloth to clean the unit, follow that product's instructions.

### To obtain a clear picture

The DVD player is a high technology, precision device. If the optical pick-up lens and disc drive parts are dirty or worn down, the picture quality deteriorates. To obtain a clear picture, we recommend regular inspection and maintenance (cleaning or parts replacement) every 1,000 hours of use depending on the operating environment. For details, contact your nearest dealer.

### Notes on moisture condensation

**Moisture condensation damages the DVD player. Please read the following carefully.**

Moisture condensation occurs, for example, when you pour a cold drink into a glass on a warm day. Drops of water form on the outside of the glass. In the same way, moisture may condense on the optical pick-up lens inside this unit, one of the most crucial internal parts of the DVD player.

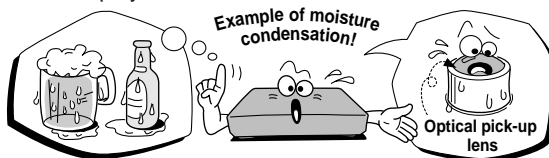

■ **Moisture condensation occurs during the following cases.**

- When you bring the DVD player directly from a cold place to a warm place.
- When you use the DVD player in a room where you just turned on the heater, or a place where the cold wind from the air conditioner directly hits the unit.
- In summer, when you use the DVD player in a hot and humid place just after you move the unit from an air conditioned room.
- When you use the DVD player in a humid place.

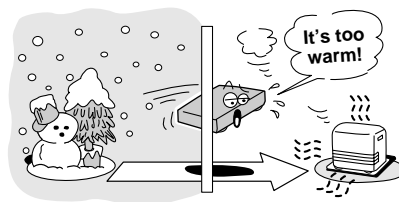

■ **Do not use the DVD player when moisture condensation may occur.**

If you use the DVD player in such a situation, it may damage discs and internal parts. Remove the disc, connect the power cord of the DVD player to the wall outlet, turn on the DVD player, and leave it for two or three hours. After two or three hours, the DVD player will have warmed up and evaporated any moisture. Keep the DVD player connected to the wall outlet and moisture condensation will seldom occur.

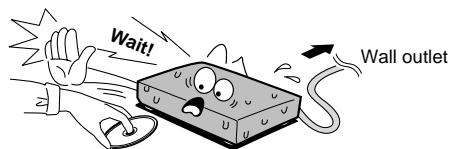



## On handling discs

- Do not touch the playback side of the disc.

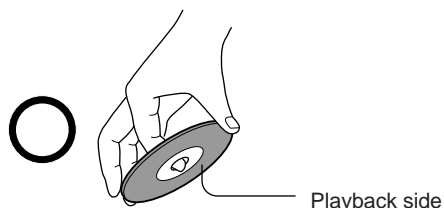

- Do not attach paper or tape to discs.



## On cleaning discs

- Fingerprints and dust on the disc cause picture and sound deterioration. Wipe the disc from the center outwards with a soft cloth. Always keep the disc clean.

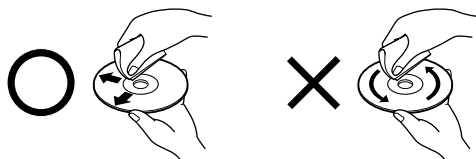

- If you cannot wipe off the dust with a soft cloth, wipe the disc lightly with a slightly moistened soft cloth and finish with a dry cloth.
- Do not use any type of solvent such as thinner, benzene, commercially available cleaners or antistatic spray for vinyl LPs. It may damage the disc.

## On storing discs

- Do not store discs in a place subject to direct sunlight or near heat sources.
- Do not store discs in places subject to moisture and dust such as a bathroom or near a humidifier.
- Store discs vertically in a case. Stacking or placing objects on discs outside of their case may cause warping.

## Structure of disc contents

Normally, DVD video discs are divided into titles, and the titles are sub-divided into chapters. VIDEO CDs/ audio CDs are divided into tracks.

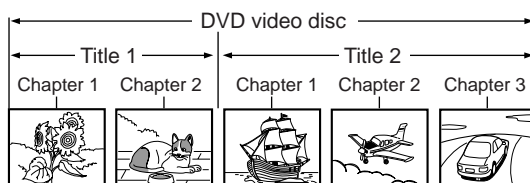

Each title, chapter or track is assigned a number, which is called "title number", "chapter number" or "track number" respectively.

There may be discs that do not have these numbers.

## Notes on copyright

It is forbidden by law to copy, broadcast, show, broadcast on cable, play in public, and rent copyrighted material without permission.

DVD video discs are copy protected, and any recordings made from these discs will be distorted.

This product incorporates copyright protection technology that is protected by method claims of certain U.S. patents and other intellectual property rights owned by Macrovision Corporation and other rights owners. Use of this copyright protection technology must be authorized by Macrovision Corporation, and is intended for home and other limited viewing uses only unless otherwise authorized by Macrovision Corporation. Reverse engineering or disassembly is prohibited.



## Notes on Discs (continued)

### About this owner's manual

This owner's manual explains the basic instructions of this DVD player. Some DVD video discs are produced in a manner that allows specific or limited operation during playback. As such, the DVD player may not respond to all operating commands. This is not a defect in the DVD player. Refer to instruction notes of discs.

"Ⓞ" may appear on the TV screen during operation. A "Ⓞ" means that the operation is not permitted by the DVD player or the disc.

### Notes on region numbers

The region number of this DVD player is 1. If region numbers, which stand for their playable area, are printed on your DVD video disc and you do not find  or , disc playback will not be allowed by the player. (In this case, the DVD player will display a message on-screen.)

### On VIDEO CDs

This DVD player supports VIDEO CDs equipped with the PBC (Version 2.0) function. (PBC is the abbreviation of Playback Control.) You can enjoy two playback variations depending on types of discs.

- **VIDEO CD not equipped with PBC function (Version 1.1)**  
Sound and movie can be played on this DVD player in the same way as an audio CD.
- **VIDEO CD equipped with PBC function (Version 2.0)**  
In addition to operation of a VIDEO CD not equipped with the PBC function, you can enjoy playback of interactive software with search function by using the menu displayed on the TV screen (Menu Playback). Some of the functions described in this owner's manual may not work with some discs.

### Playable discs

This DVD player can play the following discs.

|  | Disc Mark   | Contents                        | Disc Size        |
|--|---|---------------------------------|------------------|
| DVD video discs  |    | video (moving pictures) + Audio | 12 cm            |
|  |   |                                 | 8 cm             |
| VIDEO CDs  |    | video (moving pictures) + Audio | 12 cm            |
|  |   |                                 | 8 cm             |
| Audio CDs  |  | Audio                           | 12 cm            |
|  |   |                                 | 8 cm (CD single) |
| <p>The following discs are also available.</p> <ul style="list-style-type: none"> <li>● DVD-R discs of DVD video format</li> <li>● CD-R/CD-RW discs of CD-DA format</li> </ul> <p>Some of these discs may be incompatible.</p> |   |                                 |                  |

- You cannot play discs other than those listed above.
- You cannot play DVD-RAM discs or non-standardized discs, etc., even if they may be labeled as above.
- This DVD player uses the NTSC color system, and cannot play DVD video discs recorded in any other color system (PAL, SECAM, etc.).

# Table of Contents

## Introduction

|   |    |
|---|----|
| ● SAFETY PRECAUTIONS .....              | 2  |
| ● IMPORTANT SAFETY INSTRUCTIONS ...     | 4  |
| ● Precautions .....                     | 8  |
| ● Notes on Discs .....                  | 9  |
| Notes on region numbers .....           | 10 |
| ● Table of Contents .....               | 11 |
| ● Identification of Controls .....      | 12 |
| Front panel .....                       | 12 |
| Rear panel .....                        | 12 |
| DVD display .....                       | 13 |
| Remote control .....                    | 14 |
| Loading batteries .....                 | 15 |
| Operating with the remote control ..... | 15 |

## Connections

|  |    |
|--|----|
| ● Connecting to a TV .....   | 18 |
| Connecting to a TV .....   | 18 |
| Connecting to an audio system and TV<br>equipped with component video inputs ..... | 19 |
| ● Connecting to Optional Equipment .....   | 20 |
| Connecting to an amplifier equipped with a<br>Dolby Digital decoder .....          | 21 |
| Connecting to an amplifier equipped with<br>Dolby Surround Pro Logic .....         | 21 |
| Connecting to an amplifier equipped with a<br>DTS decoder .....                    | 22 |
| Connecting to an amplifier equipped with an<br>MPEG2 audio decoder .....           | 22 |
| Connecting to an amplifier equipped with a<br>digital audio input .....            | 23 |

## Basic playback

|  |    |
|--|----|
| ● Playing a Disc .....   | 26 |
| Basic playback .....   | 26 |
| ● Variable Speed Playback .....  | 28 |
| Playing in fast reverse or<br>fast forward directions .....              | 28 |
| Playing frame by frame .....   | 28 |
| Playing in slow-motion .....   | 29 |
| Resuming playback from the same location ...                             | 29 |
| ● Locating a Desired Section .....                                       | 30 |
| Locating a title using the top menu .....                                | 30 |
| Locating a desired section by entering its<br>corresponding number ..... | 31 |
| Locating a specific chapter or track .....                               | 31 |
| ● Playing an MP3 Encoded CD .....  | 32 |
| Playing an MP3 Encoded CD .....  | 32 |

## Advanced playback

|  |    |
|--|----|
| ● Accessing a Specific Location Directly ..                      | 34 |
| Entering the elapsed time of the desired<br>location .....       | 34 |
| ● Playing Repeatedly .....                                       | 35 |
| Repeating a title, chapter, or track .....                       | 35 |
| Repeating a specific segment .....                               | 35 |
| ● Playing in a Favorite Order .....                              | 36 |
| Setting titles, chapters, or tracks in a favorite<br>order ..... | 36 |
| ● Playing in Random Order .....                                  | 37 |
| Playing titles, chapters, or tracks in random<br>order .....     | 37 |
| ● Zooming a Picture .....  | 38 |
| Zooming a picture .....  | 38 |
| ● Selecting the Sound Enhancement<br>(E.A.M.) .....              | 39 |
| Selecting the sound enhancement .....                            | 39 |
| ● Selecting the Camera Angle .....                               | 40 |
| Changing the camera angle .....                                  | 40 |
| ● Selecting Subtitles .....                                      | 41 |
| Selecting a subtitle language .....                              | 41 |
| ● Selecting a Language .....                                     | 42 |
| Selecting a playback audio setting .....                         | 42 |

## Quick control

|  |    |
|--|----|
| ● Using the Virtual Remote Control<br>- V-REMOTE - ..... | 46 |
| ● Selecting the Playback Function<br>- QUICK - .....     | 47 |
| ● Accessing Features<br>- NAVI - .....                   | 48 |

## Function setup

|   |    |
|---|----|
| ● Customizing the Function Settings ..... | 56 |
| Setting procedure .....                   | 56 |
| Setting details .....                     | 58 |
| ● Table of Languages .....                | 65 |

## Others

|  |    |
|--|----|
| ● Before Calling Service Personnel ..... | 68 |
| ● Specifications .....                   | 69 |
| ● LIMITED WARRANTY DVD PLAYER .....      | 70 |

# Identification of Controls

See the page in  for details.

## Front panel

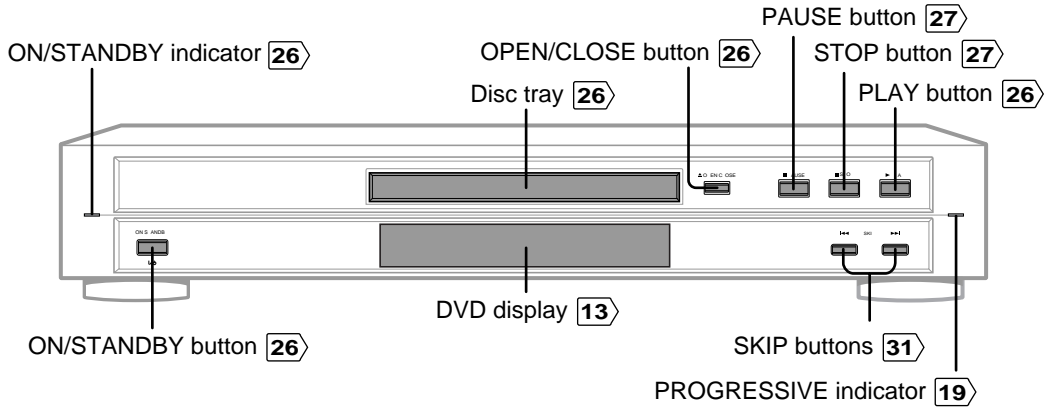

## Rear panel

VIDEO OUT (Y/Pb/Pr)  
(Component video) jacks **19**

VIDEO OUT jack **18**

BITSTREAM/PCM OPTICAL (DIGITAL)  
AUDIO OUT jack **21 22 23**

BITSTREAM/PCM COAXIAL (DIGITAL)  
AUDIO OUT jack **21 22 23**

ANALOG AUDIO OUT (L/R) jacks **18 19**

S VIDEO OUT jack **18**

SELECT (I/P) switch **19**

When connecting the optical digital cable, remove the cap and fit the connector into the jack firmly. When not using the jack, keep the cap inserted to protect it from dust intrusion.

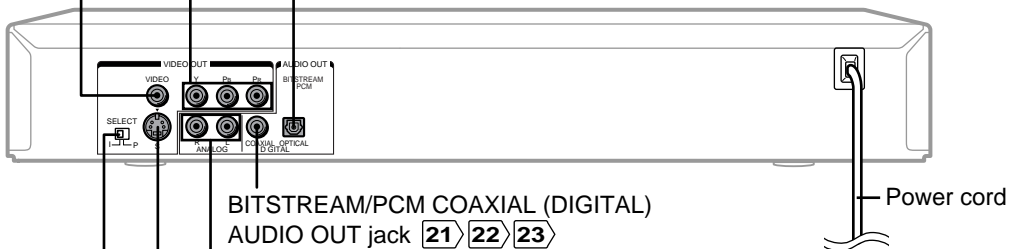
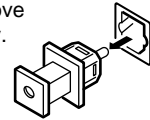

## DVD display

■ Pressing of the FL DIMMER button on the remote control changes the brightness of the display.

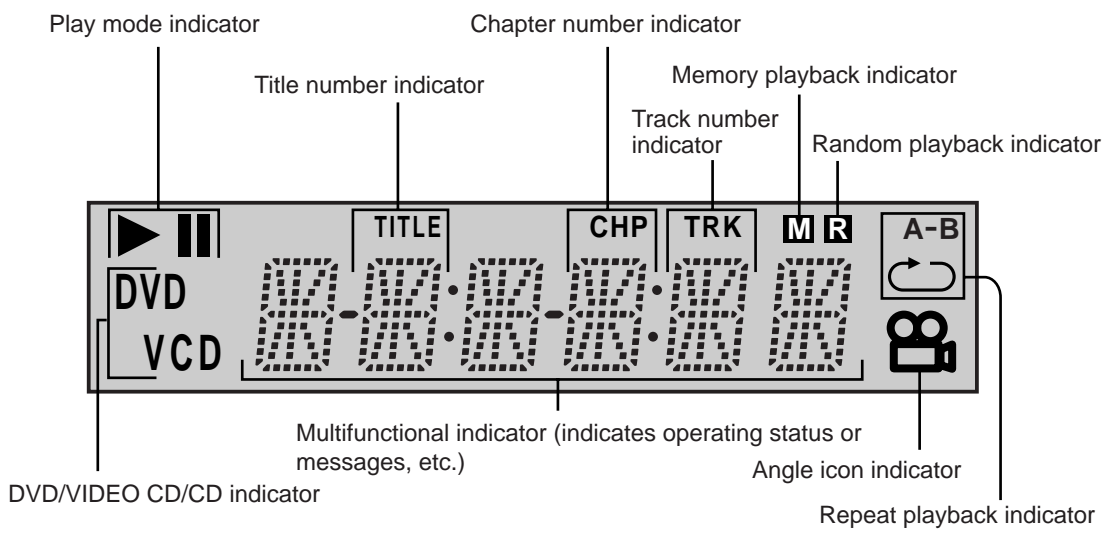
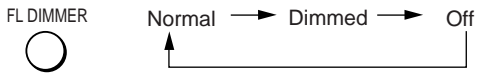

■ When you start playback, the elapsed time indicators appear. Pressing the FL SELECT button switches them to the title/chapter/track number indicators. Some discs may not permit this operation.

The indicators vary depending on the kinds of discs you play.

| DVD video disc   | VIDEO CD   | Audio CD   |
|--|--|--|
| <ul style="list-style-type: none"> <li>During playback:</li> </ul> | <ul style="list-style-type: none"> <li>During playback:</li> </ul> | <ul style="list-style-type: none"> <li>During playback:</li> </ul> |
| <p>Example</p> <p>Playing chapter 3 of title 2</p>                 | <p>Example</p> <p>Playing track 6</p>                              | <p>Example</p> <p>Playing track 6</p>                              |
| <p>Some discs may not display chapter numbers or elapsed time.</p> | <p>Some discs may not display track numbers or elapsed time.</p>   |  |

# Identification of Controls (continued)

The instructions in this manual describe the functions on the remote control. See the page in   for details.

## Remote control

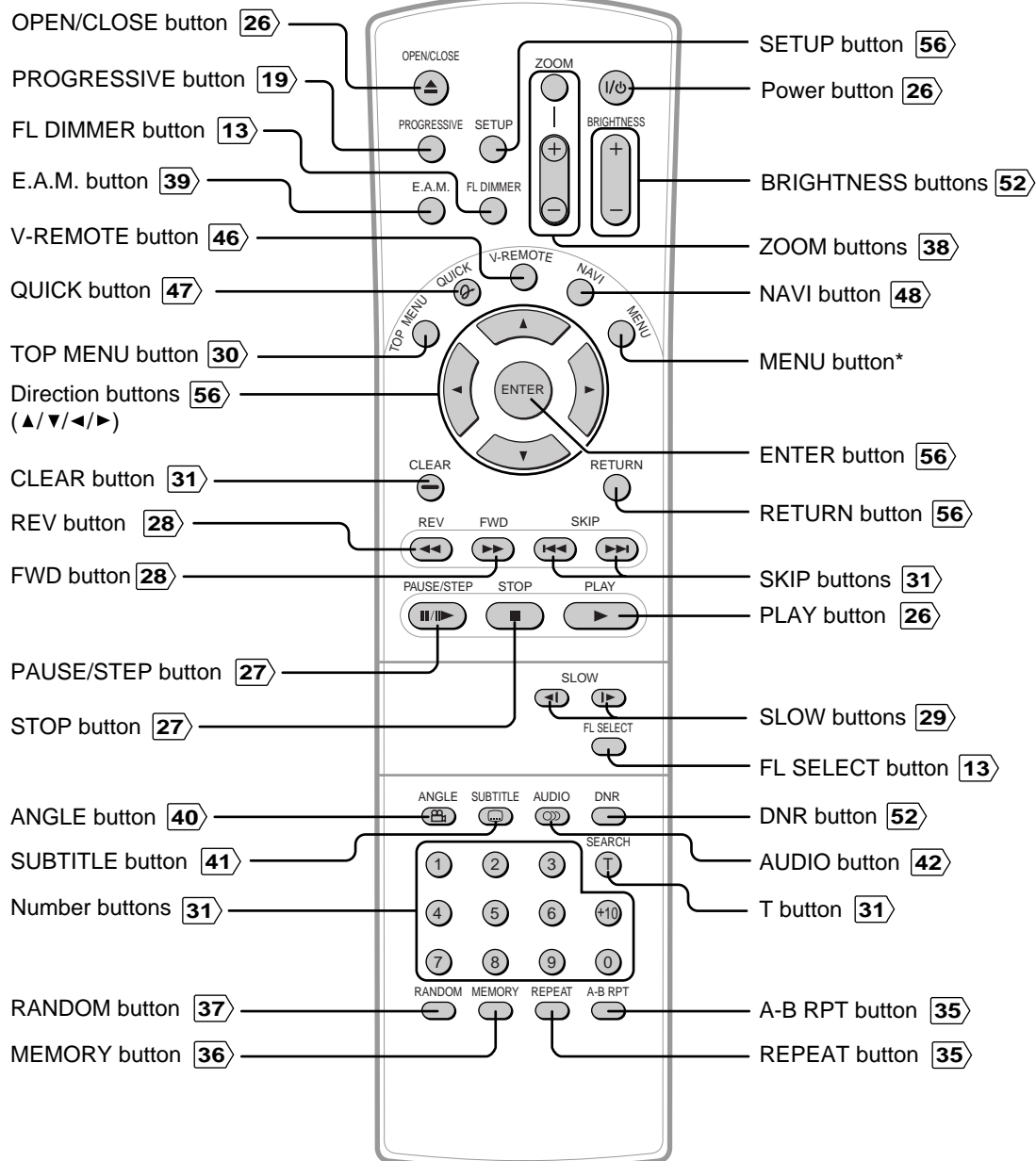

**\* MENU button**  
 Use the MENU button to display the menu included on many DVD video discs. To operate a menu, follow the instructions in "Locating a title using the top menu." 30

## Loading batteries

### 1 Open the cover.

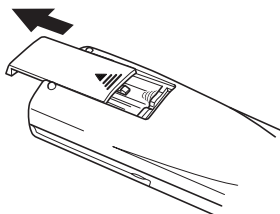

### 2 Insert batteries (AAA size).

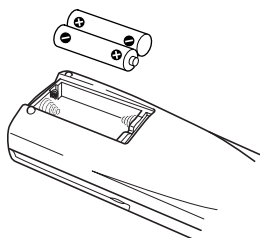

Make sure to match the + and – on the batteries to the marks inside the battery compartment.

### 3 Close the cover.

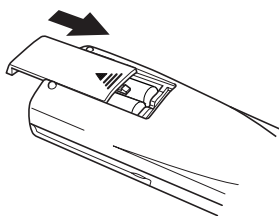

#### Notes on batteries

Improper use of batteries may cause battery leakage and corrosion. To operate the remote control correctly, follow the instructions below.

- Do not insert batteries into the remote control in the wrong direction.
- Do not charge, heat, open, or short-circuit the batteries. Do not throw batteries into a fire.
- Do not leave dead or exhausted batteries in the remote control.
- Do not use different types of batteries together, or mix old and new batteries.
- If you do not use the remote control for a long period of time, remove the batteries to avoid possible damage from battery corrosion.
- If the remote control does not function correctly or if the operating range becomes reduced, replace all batteries with new ones.
- If battery leakage occurs, wipe the battery liquid from the battery compartment, then insert new batteries.

## Operating with the remote control

Point the remote control at the remote sensor and press the buttons.

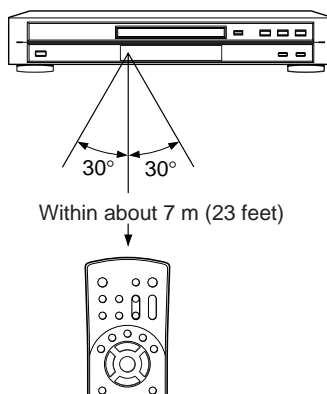

Distance: About 7 m (23 feet) from the front of the remote sensor

Angle: About 30° in each direction of the front of the remote sensor

\* Do not expose the remote sensor of the DVD player to a strong light source such as direct sunlight or other illumination. If you do so, you may not be able to operate the DVD player via the remote control.

#### Notes on the remote control

- Direct the remote control at the remote sensor of the DVD player.
- Do not drop or give the remote control a shock.
- Do not leave the remote control near an extremely hot or humid place.
- Do not spill water or put anything wet on the remote control.
- Do not open the remote control.

# Connections

Read this chapter first to make all necessary preparations.

- **Connecting to a TV**
- **Connecting to an audio system and TV equipped with component video inputs**
- **Connecting to an amplifier equipped with a Dolby Digital decoder**
- **Connecting to an amplifier equipped with Dolby Surround Pro Logic**
- **Connecting to an amplifier equipped with a DTS decoder**
- **Connecting to an amplifier equipped with an MPEG2 audio decoder**
- **Connecting to an amplifier equipped with a digital audio input**



# Connecting to a TV

Connect the DVD player to your TV.

For details of output sound, see [43](#).

## Connecting to a TV

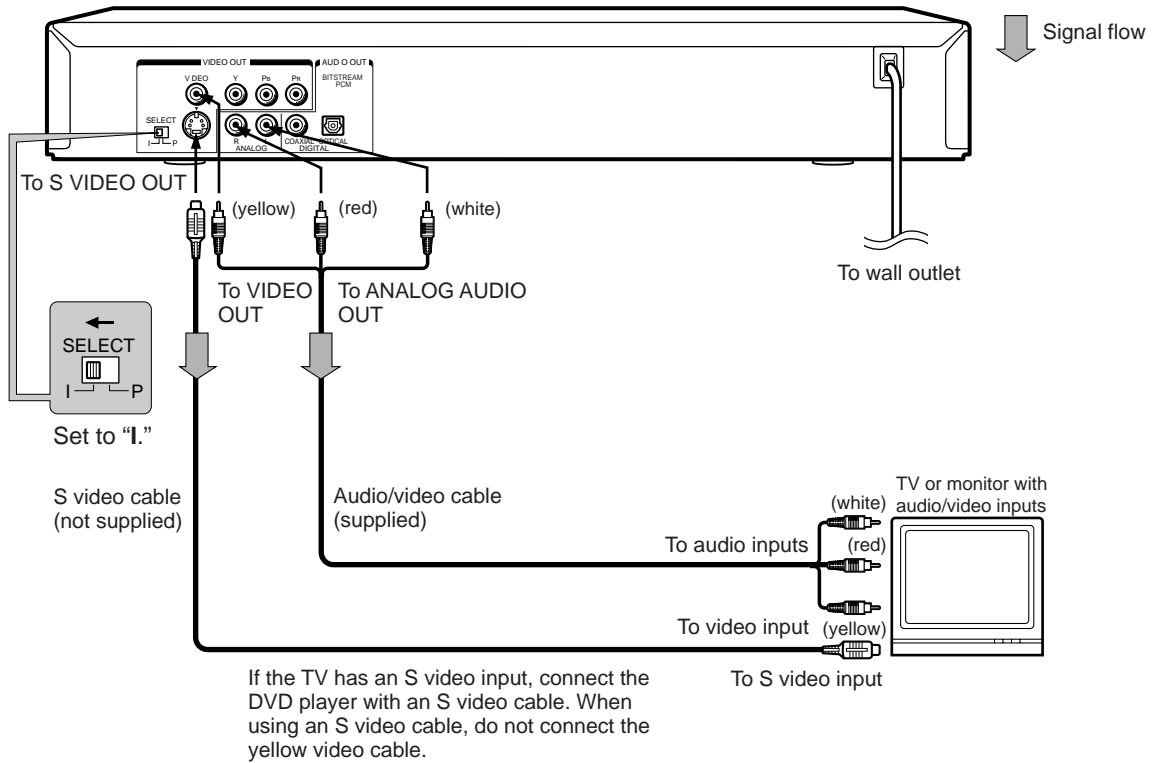

• Make the following setting.

| On-screen display | Select:              | Page                                     |
|-------------------|----------------------|--|
| "Digital Output"  | "Bitstream" or "PCM" | <a href="#">56</a><br><a href="#">59</a> |

### Notes

- Refer to the owner's manual of the connected TV as well.
- When you connect the DVD player to your TV, be sure to turn off the power and unplug both units from the wall outlet before making any connections.
- If your television set has one audio input, connect the left and right audio outputs of the DVD player to a Y cable adapter (not supplied) and then connect to your TV.
- Connect the DVD player directly to your TV. If you connect the DVD player to a VCR, TV/VCR combination or video selector, the playback picture may be distorted as DVD video discs are copy protected.

**INTERLACED outputs/inputs (ColorStream®)**

Some TVs or monitors are equipped with component video inputs. Connecting to these inputs allows you to enjoy higher quality picture playback.

Actual labels for component video inputs may vary depending on the TV manufacturer. (ex. Y, R-Y, B-Y or Y, Cb, Cr)

In some TVs or monitors, the color levels of the playback picture may be reduced slightly or the tint may change. In such a case, adjust the TV or monitor for optimum performance.

**PROGRESSIVE outputs/inputs (ColorStream®Pro)**

Some TVs or monitors are equipped with component video inputs that are capable of reproducing a progressively scanned video signal. Connecting to these inputs allows you to view the highest quality pictures with less flicker.

**Connecting to an audio system and TV equipped with component video inputs**

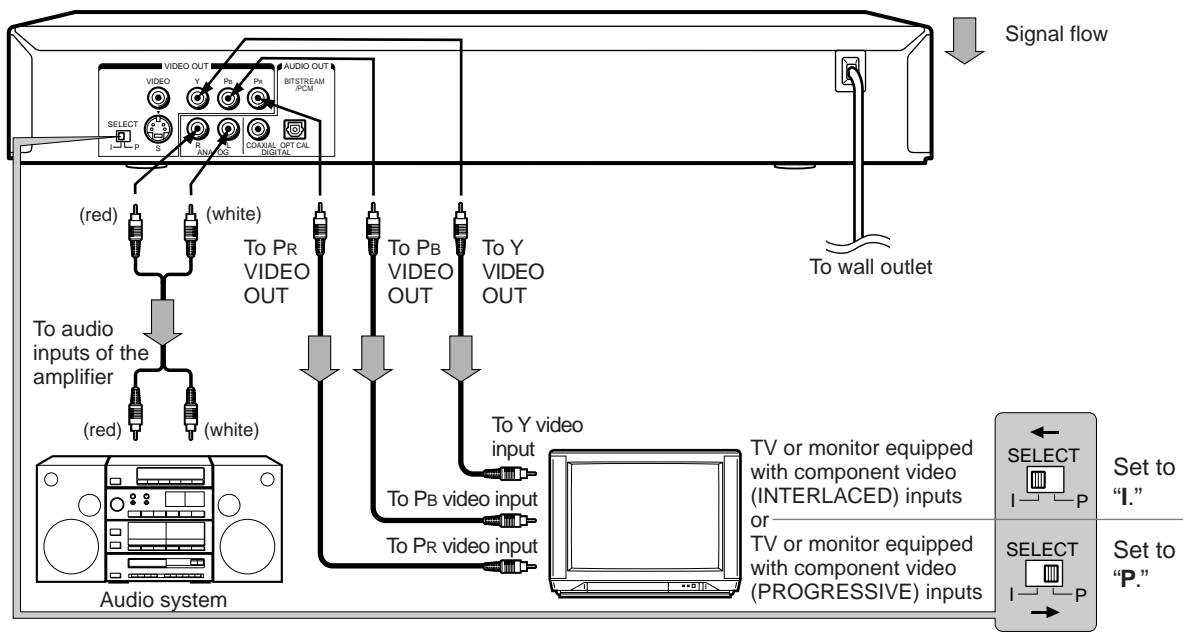

**Switching the output signal (interlaced/progressive) using the remote control (only when the SELECT (I/P) switch is set to "P")**

You can temporarily switch the output signal for better picture quality. Press **PROGRESSIVE** on the remote control. While the DVD player is outputting progressive signals, the indicator on the right side on the front panel illuminates.

\* After setting this switch (I/P), be sure to power off the DVD player then turn it on to activate the setting.

- Make the following setting.

| On-screen display | Select:              | Page     |
|-------------------|----------------------|----------|
| "Digital Output"  | "Bitstream" or "PCM" | 56<br>59 |

**Notes**

- Refer to the owner's manual of the connected equipment as well.
- When you connect the DVD player to other equipment, be sure to turn off the power and unplug all of the equipment from the wall outlet before making any connections.
- If you place the DVD player near a tuner or radio, the radio broadcast sound might be distorted. In this case, place the DVD player away from the tuner and radio.
- The output sound of the DVD player has a wide dynamic range. Be sure to adjust the receiver's volume to a moderate listening level. Otherwise, the speakers may be damaged by a sudden high volume sound.
- Turn off the amplifier before you connect or disconnect the DVD player's power cord. If you leave the amplifier power on, the speakers may be damaged.
- The S VIDEO OUT jack and the VIDEO OUT jack cannot output video signals simultaneously, if you select progressive signal when the SELECT (I/P) switch is set to "P."

## Connecting to Optional Equipment

You can enjoy high quality dynamic sounds by connecting the DVD player to optional audio equipment.

- For connection to your TV, see “Connecting to a TV” **18** **19**.
- For details of output sound, see **43**.
- This section uses the following reference marks.

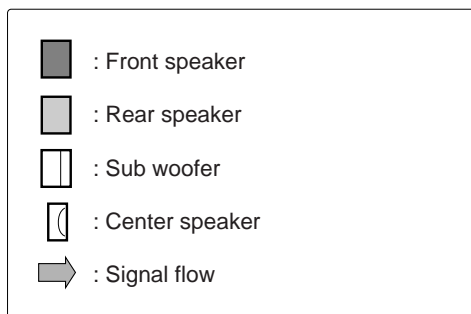

### Notes

- DO NOT connect the BITSTREAM/PCM (DIGITAL) AUDIO OUT jack of the DVD player to the AC-3 RF input of a Dolby Digital Receiver. This input on your A/V Receiver is reserved for Laserdisc use only and is incompatible with the BITSTREAM/PCM (DIGITAL) AUDIO OUT jack of the DVD player.
- Connect the BITSTREAM/PCM (DIGITAL) AUDIO OUT jack of the DVD player to the “DIGITAL (OPTICAL)” or “DIGITAL (COAXIAL)” input of a Receiver or Processor.
- Refer to the owner’s manual of the connected equipment as well.
- When you connect the DVD player to other equipment, be sure to turn off the power and unplug all of the equipment from the wall outlet before making any connections.
- The output sound of the DVD player has a wide dynamic range. Be sure to adjust the receiver’s volume to a moderate listening level. Otherwise, the speakers may be damaged by a sudden high volume sound.
- Turn off the amplifier before you connect or disconnect the DVD player’s power cord. If you leave the amplifier power on, the speakers may be damaged.

### Warning

- When you are connecting (via the BITSTREAM/PCM (DIGITAL) AUDIO OUT jack) an AV decoder that does not have Dolby Digital or MPEG2 decoding function, be sure to set “Digital Output” to “PCM” from the on-screen displays **56** **59**. Otherwise, high volume sound may damage your hearing as well as the speakers.
- DO NOT play DTS-encoded discs when you are connecting an AV decoder that does not have DTS decoding function.
- When playing DTS-encoded discs (audio CDs), excessive noise may be output from the analog audio output jacks. To avoid possible damage to the audio system, you should take proper precautions when the analog audio output jacks of the DVD player are connected to an amplification system. To enjoy DTS Digital Surround™ playback, an external 5.1 channel DTS Digital Surround™ decoder system must be connected to the BITSTREAM/PCM (DIGITAL) AUDIO OUT jack of the DVD player.

## Connecting to an amplifier equipped with a Dolby Digital decoder

### Dolby Digital

Dolby Digital is the surround sound technology used in theaters showing the latest movies, and is now available to reproduce this realistic effect in the home. You can enjoy motion picture and live concert DVD video discs with this dynamic realistic sound by connecting the DVD player to a 6 channel amplifier equipped with a Dolby Digital decoder or Dolby Digital processor. If you have a Dolby Surround Pro Logic decoder, you will obtain the full benefit of Pro Logic from the same DVD movies that provide full 5.1-channel Dolby Digital soundtracks, as well as from titles with the Dolby Surround mark.

Manufactured under license from Dolby Laboratories. "Dolby", "Pro Logic" and the double-D symbol are trademarks of Dolby Laboratories. Confidential unpublished works. Copyright 1992-1997 Dolby Laboratories. All rights reserved.

- Use DVD video discs encoded via the Dolby Digital recording system.
- Make the following setting.

| On-screen display | Select:     | Page      |
|-------------------|-------------|-----------|
| "Digital Output"  | "Bitstream" | <b>56</b> |
|                   | "Bitstream" | <b>59</b> |
| Recording system  | D D         | <b>42</b> |

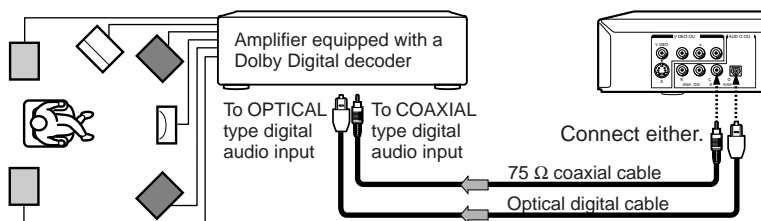

## Connecting to an amplifier equipped with Dolby Surround Pro Logic

### Dolby Surround Pro Logic

You can enjoy the dynamic realistic sound of Dolby Surround Pro Logic by connecting an amplifier and speaker system (right and left front speakers, a center speaker, and one or two rear speakers).

#### ■ With an amplifier equipped with Dolby Digital

Connect the equipment the same way as described in "Connecting to an amplifier equipped with a Dolby Digital decoder." Refer to that amplifier's owner's manual and set the amplifier so you can enjoy Dolby Surround Pro Logic sound.

#### ■ With an amplifier not equipped with Dolby Digital

Connect the equipment as follows.

- Make the following setting.

| On-screen display | Select:              | Page      |
|-------------------|----------------------|-----------|
| "Digital Output"  | "Bitstream" or "PCM" | <b>56</b> |
|                   |                      | <b>59</b> |

**Be sure to set "Digital Output" to "Bitstream" or "PCM" when you enjoy sounds of Dolby Surround Pro Logic using this connection.**

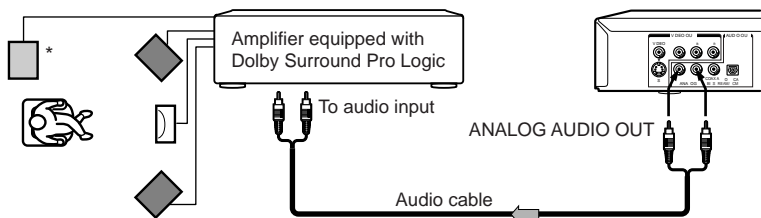

\* Connect one or two rear speakers. The output sound from the rear speakers will be monaural even if you connect two rear speakers.

# Connecting to Optional Equipment (Continued)

## Connecting to an amplifier equipped with a DTS decoder

### Digital Theater Systems (DTS)

DTS is a high quality surround technology used in theaters and now available for home use, on DVD video discs or audio CDs.

If you have a DTS decoder or processor, you can obtain the full benefit of 5.1 channel DTS encoded sound tracks on DVD video discs or audio CDs.

"DTS" and "DTS Digital Out" are trademarks of Digital Theater Systems, Inc.

- Use DVD video discs or audio CDs encoded via the DTS recording system.
- Make the following setting.

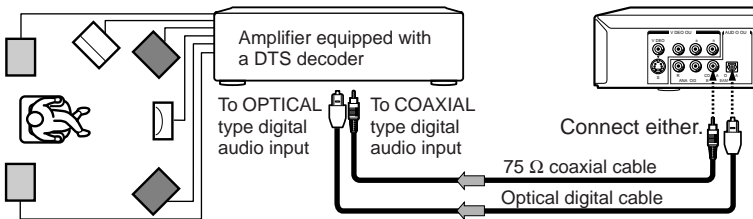

| On-screen display | Select:     | Page      |
|-------------------|-------------|-----------|
| "Digital Output"  | "Bitstream" | <b>56</b> |
|                   | "PCM"       | <b>59</b> |
| Recording system  | DTS         | <b>42</b> |

## Connecting to an amplifier equipped with an MPEG2 audio decoder

### MPEG2 sound

You can enjoy motion picture and live concert DVD video discs with dynamic realistic sound by connecting an amplifier equipped with an MPEG2 audio decoder or MPEG2 audio processor.

- Use DVD video discs encoded via the MPEG2 recording system.
- Make the following setting.

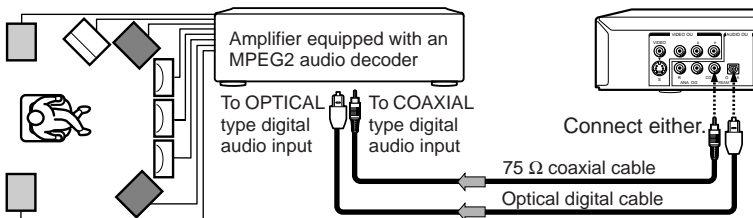

| On-screen display | Select:     | Page      |
|-------------------|-------------|-----------|
| "Digital Output"  | "Bitstream" | <b>56</b> |
|                   | "PCM"       | <b>59</b> |
| Recording system  | MPEG2       | <b>42</b> |

## Connecting to an amplifier equipped with a digital audio input

### 2 channel digital stereo

You can enjoy the dynamic sound of 2 channel digital stereo by connecting an amplifier equipped with a digital audio input and speaker system (right and left front speakers).

- Make the following setting.

| On-screen display | Select: | Page      |
|-------------------|---------|-----------|
| "Digital Output"  | "PCM"   | <b>56</b> |
|                   |         | <b>59</b> |

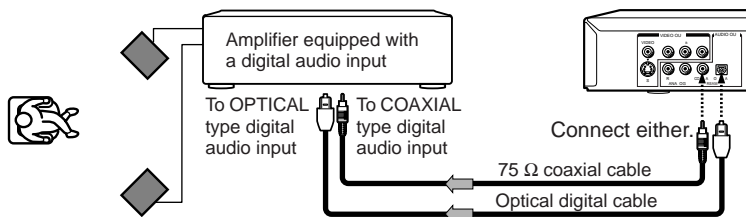





# **Basic playback**

Begin your operation.

- **Playing a Disc**
- **Variable Speed Playback**
- **Locating a Desired Section**
- **Playing an MP3 Encoded CD**



## Playing a Disc

This section shows you the basics on how to play a disc.

### CAUTION

Keep your fingers well clear of the disc tray as it is closing. Neglecting to do so may cause serious personal injury.

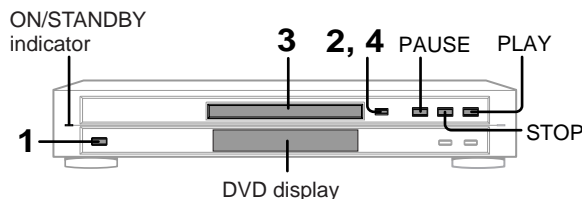

## DVD-V VCD CD Basic playback

### Preparations

- When you want to view a disc, turn on the TV and select the video input connected to the DVD player.
- When you want to enjoy the sound of discs from the audio system, turn on the audio system and select the input connected to the DVD player.

### 1 Press the power button (ON/STANDBY).



The DVD player turns on and the ON/STANDBY indicator on the player illuminates.

When the DVD player is turned on for the first time, an on-screen display will appear to provide initial settings. Press the  $\blacktriangle$  /  $\blacktriangledown$  buttons to select an item, and press the ENTER button. See the pages in  $\square$ , and make a selection using the  $\blacktriangle$  /  $\blacktriangledown$  buttons, then press the ENTER button.

On-Screen Language  $\square$   
TV Shape  $\square$

After making all the settings, select " $\square$ " and press the ENTER button.

### 2 Press OPEN/CLOSE.



The disc tray opens.

### 3 Place a disc on the disc tray.

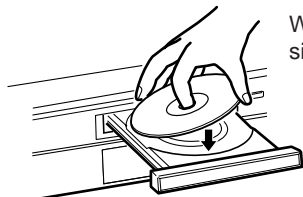

With the playback side down.

- There are two different disc sizes. Place the disc in the correct guide on the disc tray. If the disc is out of the guide, it may damage the disc and cause the DVD player to malfunction.
- Do not place a disc which is unplayable in this DVD player.

### 4 Press OPEN/CLOSE to close the disc tray.



Playback starts.

If you insert a DVD video disc that contains a top menu, a menu may appear. See "Locating a title using the top menu."  $\square$   
You may need to press the TOP MENU or MENU button to display disc menu (depending on the actual DVD video disc.)

### Note

If the disc tray contains a disc you have already played, playback will begin from the location where you last stopped playback.  $\square$

### To start playback in the stop mode

Press PLAY.



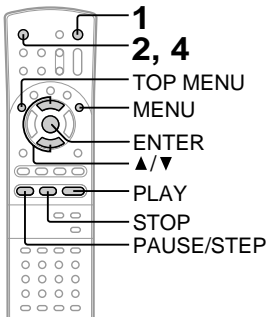

■ **To obtain a higher quality picture**

Occasionally, some picture noise not usually visible during a normal broadcast may appear on the TV screen while playing a DVD video disc because the high resolution pictures on these discs include a lot of information. While the amount of noise depends on the TV you use with this DVD player, you should generally reduce the sharpness adjustment on your TV when viewing DVD video discs.

■ **About DVD-V VCD CD**

The DVD-V VCD CD icons on the heading bar show the playable discs for the function described under that heading.

- DVD-V : DVD video discs.
- VCD : VIDEO CDs.
- CD : Audio CDs.

■ **To pause playback (still mode)**

Press **PAUSE/STEP** during playback.

PAUSE/STEP



To resume normal playback, press the **PLAY** button.

- Sound is muted during still mode.

■ **To stop playback**

Press **STOP**.

STOP



■ **To remove the disc**

Press **OPEN/CLOSE**.

OPEN/CLOSE



Remove the disc after the disc tray opens completely.

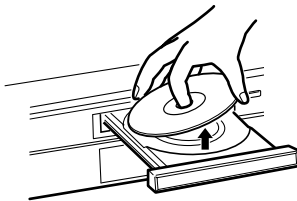

Be sure to press the **OPEN/CLOSE** button to close the disc tray after you remove the disc.

■ **About the screen saver**

If you pause a picture of a DVD video disc and leave it still for a long while, the screen saver of the DVD player automatically appears (when "Screen Saver" is set to "On" [62]). To turn off the screen saver, press the **PLAY** button.

■ **Automatic Power Off function**

If the DVD player is stopped, or the screen saver is engaged for approximately 20 minutes, the DVD player will automatically turn itself off.

**Notes**

- Do not move the DVD player during playback. Doing so may damage the disc.
- Use the **OPEN/CLOSE** button to open and close the disc tray. Do not push the disc tray while it is moving. Doing so may cause the DVD player to malfunction.
- Do not push up on the disc tray or put any objects other than discs on the disc tray. Doing so may cause the DVD player to malfunction.
- In many instances, a menu screen will appear after playback of a movie is completed. Prolonged display of an on-screen menu may damage your television set, permanently etching that image onto its screen. To avoid this, be sure to press the **STOP** button twice on your remote control once the movie is completed.

## Variable Speed Playback

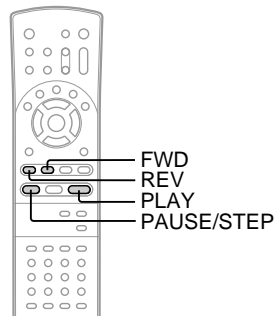

You can play discs at various speeds, and resume playback from the location where you stopped playback.



### DVD-V VCD CD Playing in fast reverse or fast forward directions

#### Press REV or FWD during playback.

REV FWD REV : Fast reverse playback  
FWD: Fast forward playback

Each time you press the REV or FWD button, the playback speed changes.

#### ■ To resume normal playback

Press **PLAY**.



#### Notes

- The DVD player mutes sound and omits subtitles during reverse and forward scan of DVD video discs.
- The playback speed may differ depending on the disc.

### DVD-V VCD CD Playing frame by frame

#### Press PAUSE/STEP during still playback.

PAUSE/STEP Each time you press the PAUSE/STEP button, the picture advances one frame.



#### ■ To resume normal playback

Press **PLAY**.





#### Note

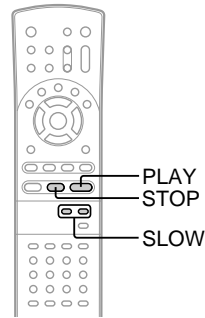

The sound is muted during frame by frame playback.



DVD-V VCD  
CD **Playing in slow-motion**

**Press SLOW during playback.**

SLOW  Each time you press the SLOW  button, the slow-motion speed changes.

SLOW  If you press the SLOW  button during playback, you can view the picture in reverse slow-motion. (Only when using a DVD video disc.)

Each time you press the SLOW  button, the slow-motion speed changes.

**To resume normal playback**

Press **PLAY**.



**Notes**

- The sound is muted during slow-motion playback.
- The playback speed may differ depending on the disc.

DVD-V VCD  
CD **Resuming playback from the same location**

**1 Press STOP at the location where you want to interrupt playback.**

STOP  The DVD player memorizes the location where playback is stopped.

**2 Press PLAY.**

PLAY  The DVD player resumes playback from the location where you stopped playback.

**2 Press PLAY.**



DVD-V Playback starts from the beginning of the current title.  
VCD Playback starts from the beginning of the disc.  
CD

- If you want to return to the beginning of a DVD video disc, open and close the disc tray once with the OPEN/CLOSE button before pressing the PLAY button.

**Notes**

- Resuming cannot function when:
  - you change the parental lock setting **[62]** or select a disc menu language **[60]**.
  - you play a PBC-featured VIDEO CD while “PBC” **[64]** is set to “On.”
  - you open the disc tray.
- There may be a difference in the location where playback resumes depending on the disc.
- Settings you changed using the on-screen displays while the DVD player keeps a location in the memory may function only after the memory is cleared.

**To start playback from the beginning regardless of the location where you stopped playback**

**1 Press STOP twice.**

STOP  The DVD player erases the previous location from its memory.

# Locating a Desired Section

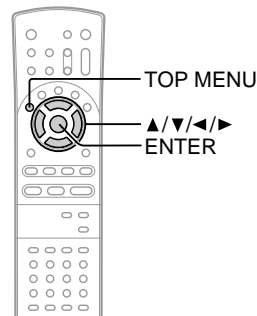

Normally, DVD video discs are divided into titles, and the titles are sub-divided into chapters. VIDEO CDs and audio CDs are divided into tracks. You can quickly locate any specific title, chapter, or track.

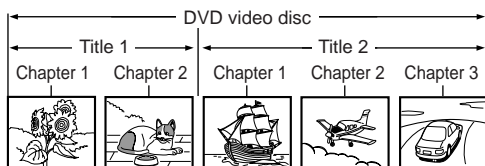

## DVD-V VCD CD Locating a title using the top menu

### 1 Press TOP MENU.



The top menu appears on the TV screen.

e.g.

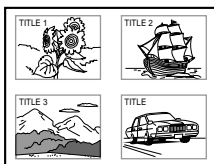

### 2 Press ▲/▼/◀/▶ to select the title you want.

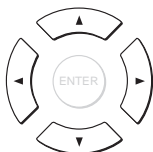

If the titles in the top menu are assigned a number, you can directly locate a specific title by pressing its designated number with the number buttons.

### 3 Press ENTER.



Playback starts from chapter 1 of the selected title.

#### Notes

- The instructions above describe basic procedures which may vary depending on the contents of the DVD video disc. If different instructions appear on the TV screen, follow those instructions.
- If you display the top menu during playback and press the TOP MENU button again without selecting any title, the DVD player may resume playback from the point where you first pressed the TOP MENU button (depending on the actual DVD video disc.)
- This method of locating a title is available only on a disc that contains a top menu.
- Instruction notes of discs may refer to the button that displays the top menu as TITLE button.

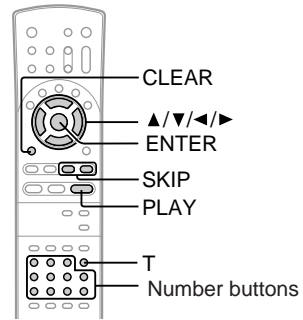

**DVD-V VCD**  
**CD** **Locating a desired section by entering its corresponding number**

**1 Press T.**

If you are using a VIDEO CD/audio CD, skip steps 1 and 2. Then at step 3, enter the number for the track you want using the number buttons.

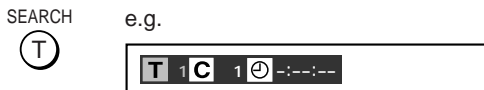

**2 Press ◀/▶ to select a section you want to locate.**



e.g. When you want to locate a chapter.



**3 Press ▲/▼ to enter a number of the section.**

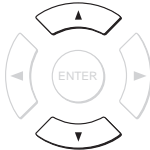

Also the number buttons are available.

e.g. To enter 25

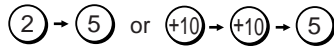

**4 Repeat steps 2 and 3 if necessary.**

**5 Press PLAY or ENTER.**



**Notes**

- Pressing the CLEAR button resets the numbers. To clear the display, press the T button several times.
- This method of locating a title is available only on a disc that contains title numbers.

Basic playback

**DVD-V VCD**  
**CD** **Locating a specific chapter or track**

**Press SKIP ◀◀ or ▶▶ repeatedly to display the chapter or track number you want.**

Playback starts from the selected chapter or track.

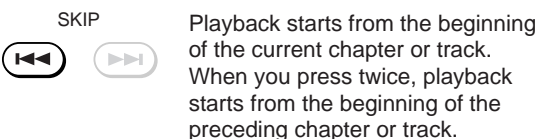
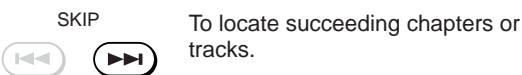

**Notes**

- Some titles may not display chapter numbers.
- When you set "Title Stop" to "Off" [64], you can access chapters in another title. If you go back to the preceding title by pressing the SKIP ◀◀ button, the DVD player locates the first chapter of the title. When "Title Stop" is set to "On," you can access chapters only within the current title.
- If you press and hold the SKIP ◀◀ or ▶▶ button on the front panel during playback, the DVD player performs fast reverse or fast forward playback. You can vary the speed by pressing the button further. To locate chapters or tracks during fast reverse or fast forward playback, first press the PLAY button to resume normal playback, then use the SKIP ◀◀ or ▶▶ button.

# Playing an MP3 Encoded CD

You can play MP3 files on this DVD player.

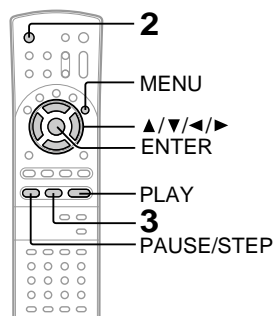

## Playing an MP3 encoded CD

MP3 disc compatibility with this player is limited as follows:

- Playable discs: CD-ROM, CD-R (650MB / 74 min. only)  
CD-RW is not recommendable.
- Sampling Frequency: 44.1 kHz only
- Bit rate 32 kbps-320 kbps
- CD physical format: Mode 1, Mode 2 XA Form 1
- File system: ISO9660 Level 1
- File names are limited to eight characters or less and must incorporate "MP3" extension.  
e.g. "\*\*\*\*\*.MP3"
- File names cannot contain special characters such as "?!><+\*}{ [ @ ; \ / , ." etc.
- Total number of files on the disc should not exceed 254.

### Preparations

- When you playback an MP3 encoded CD, set "Priority Contents" to "[MP3] > [JPG]". [64]

### To pause playback

Press **PAUSE/STEP** during playback.

PAUSE/STEP



To resume normal playback, press the **PLAY** button.

### Selecting a track (file) in the disc

- 1 If a track list is not displayed, press the MENU button to show it.  
The current track being played is highlighted in red.
- 2 Press the ▲ / ▼ / ◀ / ▶ buttons to select a track you want to play.  
The selected track is highlighted in green.
- 3 Press the ENTER button to begin playback of the selected track.

### Notes

- Some discs may not permit this operation.
- If you stop playback by pressing the STOP button, and then press the PLAY button, playback will start from the beginning of the track.
- The SKIP [31], REPEAT [35] and RANDOM [37] functions are also available.

**1 Place a CD that contains MP3 files on the disc tray.**

**2 Press OPEN/CLOSE to load the disc.**

OPEN/CLOSE

Playback starts.



To start playback from stop mode, press the PLAY button.

**3 To stop playback, press STOP.**

STOP



This DVD player requires discs/recordings to meet certain technical standards in order to achieve optimal playback quality. Pre-recorded DVDs are automatically set to these standards. There are many different types of recordable disc formats (including CD-R containing MP3 files). Given the fact that technology in this area is still maturing, Toshiba cannot guarantee that all genre of recordable discs will produce optimal playback quality. The technical criteria set out in this owner's manual are meant as a guide only.

Customers should also note that permission is required in order to download MP3 files and music from the internet. Toshiba has no right to grant such permission. Permission should always be sought from the copyright owner.

# Advanced playback

---

Customizing the performance of your DVD player.

- **Accessing a Specific Location Directly**
- **Playing Repeatedly**
- **Playing in a Favorite Order**
- **Playing in Random Order**
- **Zooming a Picture**
- **Selecting the Sound Enhancement (E.A.M.)**
- **Selecting the Camera Angle**
- **Selecting Subtitles**
- **Selecting a Language**



# Accessing a Specific Location Directly

You can access a specific location by entering its corresponding elapsed time (hours, minutes, seconds).

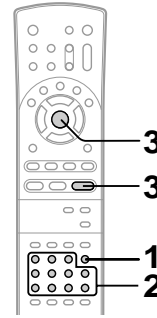

DVD-V VCD  
CD

## Entering the elapsed time of the desired location

### 1 Press T several times.



You may have to press further depending on the disc. Press the button repeatedly until the clock icon is highlighted.

e.g.



### 2 Press the number buttons to enter the elapsed time.

e.g.

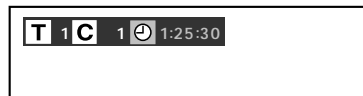

### 3 Press PLAY or ENTER.

PLAY



Playback starts from the desired location.



#### Notes

- Some discs may not respond to this process.
- Some scenes may not be located precisely as you specified.
- This method for accessing specific locations is available only within the current title of the DVD video disc or within the current track of the VIDEO CD/audio CD.

# Playing Repeatedly

You can play a specific title, chapter, or segment repeatedly.

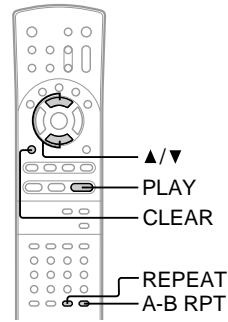
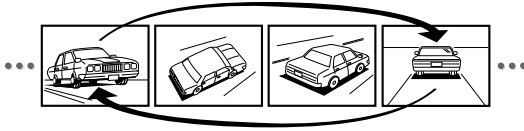

## DVD-V VCD CD Repeating a title, chapter, or track

### 1 Press REPEAT.

REPEAT The repeat mode menu appears.



### 2 Press REPEAT or ▲ / ▼ repeatedly to select the repeat playback mode.

REPEAT The mode changes as follows (when using the REPEAT button):

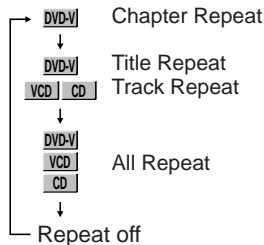
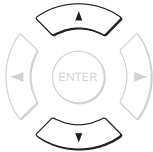

- Chapter Repeat: Repeats the current chapter.
- Track Repeat: Repeats the current track.
- Title Repeat: Repeats the current title.
- All Repeat: Repeats the entire disc.
- Repeat Off: Resumes normal playback.

If you select the repeat mode during playback, the DVD player automatically starts repeat playback after finishing the current title, chapter, or track.

### 3 Press PLAY.

PLAY The DVD player starts repeat playback. Press the PLAY button within about 5 seconds after you press the REPEAT button.



#### ■ To resume normal playback

Press CLEAR.



#### Note

Some discs may not permit repeat operation.

## DVD-V VCD CD Repeating a specific segment

### 1 Press A-B RPT at the beginning of the segment (point A) you want to play repeatedly.

A-B RPT



### 2 Press A-B RPT again at the end of the segment (point B).

A-B RPT



The DVD player automatically returns to point A and starts repeat playback of the selected segment (A-B).



#### ■ To resume normal playback

Press CLEAR.



#### Notes

- Some discs may not permit A-B repeat operation.
- You cannot set the A-B repeat function for a segment that includes multiple camera angles **[40]**.
- You can specify a segment only within the current title.
- There may be a slight difference between point A and the location where playback actually resumes depending on the disc.

## Playing in a Favorite Order

You can combine your favorite titles, chapters, or tracks and play them in the order you determine. You can program up to 30 selections into the memory. (Memory playback)

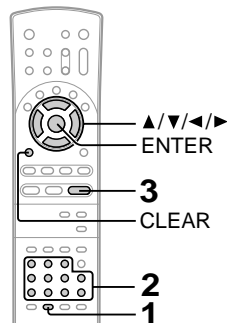

### DVD-V VCD CD Setting titles, chapters, or tracks in a favorite order

#### 1 Insert a disc and press MEMORY during stop.

MEMORY The following display appears.

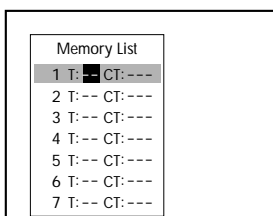

T: Title number  
CT: Chapter number or track number

#### 2 Select the items in the order you want by pressing the number buttons, then ENTER for each item.

Each time you press the ◀/▶ buttons, the spaces of "T" and "CT" are highlighted in turn. Highlight where you want to enter, then press the corresponding number buttons.

To select another chapter in the same title, you do not need to select the title number.

To select tracks from a VIDEO CD/audio CD in order, press the **number buttons** for the track, then press the **ENTER** button for each selection you want.

#### 3 Press PLAY while the display appears on the TV screen.

PLAY The DVD player starts memory playback.



#### ■ To change the programmed selections

- 1 While the display appears on the TV screen, press the ▲/▼/◀/▶ buttons to highlight the item you want to change.
- 2 Change the selection following the instructions in step 2.

#### ■ To cancel the programmed selections

- 1 While the display appears on the TV screen, press the ▲/▼ buttons to highlight the item you want to cancel.
- 2 Press **CLEAR**.

#### ■ To resume normal playback from memory playback

Press **CLEAR**.



The memory playback indicator disappears.

#### Notes

- Some discs may not permit memory playback operation.
- If you press the REPEAT button during memory playback, the DVD player repeats the current memory playback.
- If you press the MEMORY or RETURN button while the display appears on the TV screen, the display disappears.
- The programmed selections will be cleared when:
  - you turn off the DVD player.
  - you open the disc tray.

# Playing in Random Order

You can play titles, chapters, or tracks in random order.  
(Random playback)

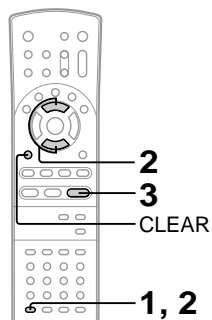

**DVD-V | VCD | CD** **Playing titles, chapters, or tracks in random order**

**1 Press RANDOM.**  
RANDOM The random mode menu appears.



**2 Press RANDOM or ▲ / ▼ repeatedly to select the random playback mode.**

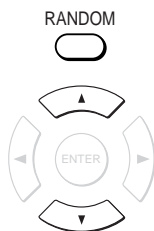

The mode changes as follows (when using the RANDOM button):

- DVD-V** Chapter Random Plays the chapters within the current title in random order.
- ↓
- DVD-V** Title Random Plays titles in random order.
- VCD** Track Random Plays tracks in random order.
- CD** Track Random Plays tracks in random order.
- ↓
- Random Off Resumes normal playback.

If you select the random mode during playback, the DVD player automatically starts random playback after finishing the current title, chapter, or track.

**3 Press PLAY.**  
PLAY The DVD player starts random playback.  
Press the PLAY button within about 5 seconds after you press the RANDOM button.



**■ To resume normal playback**

Press CLEAR.



**Notes**

- Some discs may not permit random playback operation.
- You cannot use the random playback function in conjunction with the memory playback function.

# Zooming a Picture

You can magnify areas within a picture.

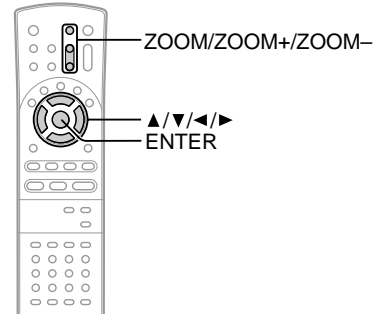
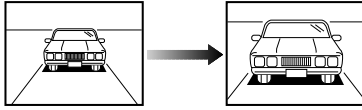

## DVD-V VCD Zooming a picture

### 1 During normal, slow or still playback, press ZOOM, ZOOM+ or ZOOM-.

**ZOOM**

The DVD player enters the zoom mode, and a monitor scope and an icon appear.

e.g.

### 2 Select the zoom point and magnification level.

#### Magnification level

- To use the fixed levels:
  - You can select from the following.
    - Magnification
    - Image reduction
    - Normal playback

**ZOOM**

Press the **ZOOM** button repeatedly.

Alternatively press the **▲/▼/◀/▶** buttons to select “ZOOM” on the icon, and press the **ENTER** button repeatedly.

- To zoom in (or to zoom out):

Press repeatedly or press and hold the **ZOOM+** (or **ZOOM-**) button.

#### Zoom point

To shift:

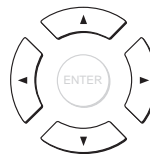

Press the **▲/▼/◀/▶** buttons.

#### ■ To hide the monitor scope and the icon during zoom playback

Press **▲/▼/◀/▶** to select “EXIT,” and press **ENTER**.

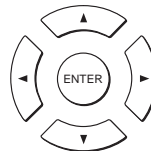

#### ■ To resume normal playback

Press **ZOOM** repeatedly until the monitor scope and the icon disappear.

Alternatively press **▲/▼/◀/▶** to select “ZOOM” on the icon, and press **ENTER** repeatedly until the monitor scope and the icon disappear.

#### Notes

- Some discs may not respond to zoom feature.
- During some scenes, the buttons may not work as described.
- Zooming does not work on subtitles or menus included on DVD video discs.
- While the icon is displayed, the **▲/▼/◀/▶/ENTER** buttons cannot work on menus included on DVD video discs. If you want to view the menus, cancel the zoom playback.
- The magnification level varies depending on the picture size you select. **58**

# Selecting the Sound Enhancement (E.A.M.\*)

You can easily switch a preferred audio enhancement.

\*E.A.M.: Enhanced Audio Mode

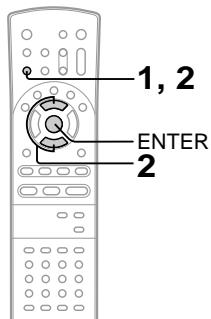

## DVD-V VCD CD Selecting the sound enhancement

### 1 Press E.A.M.

E.A.M.



The sound enhancement menu appears.



### 2 Press E.A.M. or ▲ / ▼ repeatedly to select the sound enhancement.

E.A.M.



Normal:

Normal sound.

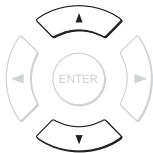

3D:

To obtain expansive virtual surround sound effects from just two speakers.



Dialogue:

To control critical center channel information to make dialogue more intelligible (only when playing a DVD video disc recorded on the Dolby Digital recording system).

- To use this enhancement on sounds output from the BITSTREAM/PCM (DIGITAL) AUDIO OUT jack, be sure to set "Digital Output" to "PCM". [59](#)

### ■ To exit the audio enhancement selection

Press **ENTER**.



Alternatively leave the DVD player unattended for about 5 seconds after having made a selection.

### Notes

- Actual effects to sounds may vary depending on the speaker systems. Make selection according to your preference.
- Actual effects to sounds may vary depending on the disc.
- When the DVD player is connected to an amplifier equipped with Dolby Surround Pro Logic, select "Normal". Otherwise, Dolby Surround Pro Logic may function differently than usual.
- Selecting "Dialogue" disables "Dynamic Range Control" function [59](#).

Spatializer® 3-Dimensional Sound Processing provided by Desper Products, Inc.  
Certain audio features of this product manufactured under a license from Desper Products, Inc., Spatializer® and the circle-in-square device are trademarks owned by Desper Products, Inc.

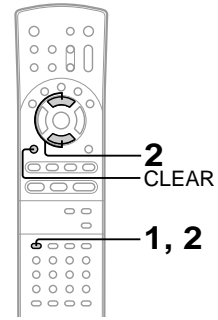
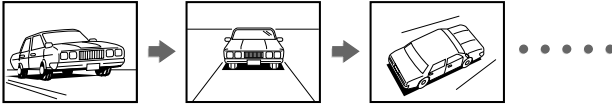

## Selecting the Camera Angle

If the scene was recorded from multiple angles, you can easily change the camera angle of the scene you are watching.



### DVD-V VCD CD Changing the camera angle

#### 1 Press ANGLE while playing a scene recorded with multiple angles.

**ANGLE**  
 While playing a scene recorded with multiple angles, the angle icon () flashes in the DVD display. Press the ANGLE button while the angle icon is flashing.

e.g.



#### 2 Press ANGLE or ▲ / ▼ while the angle number is displayed on the TV screen.

**ANGLE**  
 Each time you press the ANGLE button or the ▲ / ▼ buttons, the camera angle changes.

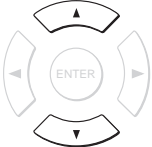

You can change the camera angle directly by pressing the number buttons corresponding to its angle number instead of using the ▲ / ▼ buttons.

#### ■ To turn off the angle number display

Press **CLEAR**.

CLEAR



#### Notes

- You can change the camera angle during still playback. The camera angle changes to the new setting when you resume normal playback.
- If you pause a picture immediately after changing a camera angle, the resumed playback picture may not display the new camera angle.

# Selecting Subtitles

You can display subtitles on the TV screen and select a subtitle language from those included on the DVD video disc.

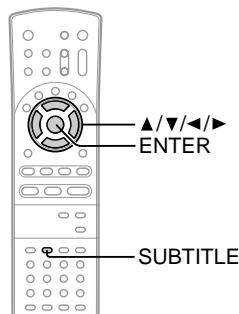
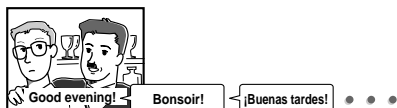

## DVD-V VCD CD Selecting a subtitle language

### 1 Press SUBTITLE during playback.

**SUBTITLE** The current subtitle setting is displayed.



e.g.



The abbreviation of the language appears instead of the language name. Refer to the list of languages and their abbreviations. **65**

### 2 Press SUBTITLE or ▲ / ▼ while the subtitle setting is displayed on the TV screen.

**SUBTITLE** Each time you press the SUBTITLE button or the ▲ / ▼ buttons, the subtitle languages included on the DVD video disc change.

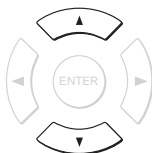

To turn off the subtitle setting display, press the ENTER button.

### ■ To turn subtitles on or off

1 Press **SUBTITLE** during playback.

**SUBTITLE**



2 Press ◀ / ▶ while the subtitle setting is displayed on the TV screen, to select "On" or "Off."

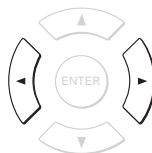

### Notes

- Some DVD video discs are set to display subtitles automatically, and you cannot turn them off even if you set the subtitle function to off.
- During some scenes, the subtitles may not appear immediately after you select "On."
- Some DVD video discs will allow you to make subtitle selections and turn subtitles on or off only via the disc menu.

### Notes

- When you turn on the DVD player or replace a disc, the player returns to the initial default setting **61**.
- When you select a subtitle language which is not included on the disc, the DVD player plays a prior language programmed on the disc.
- During some scenes, the subtitles may not appear immediately after you change the subtitle language.



# Selecting a Language

You can select a preferred language and sound recording system from those included on the disc.

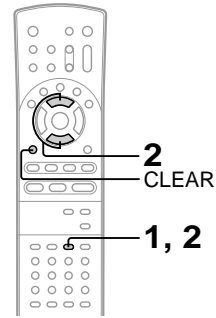
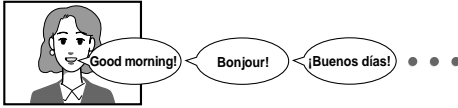

## DVD-V VCD CD Selecting a playback audio setting

### 1 Press AUDIO during playback.

**AUDIO**  
 The current audio setting is displayed.

e.g.



The abbreviation of the language appears instead of the language name. Refer to the list of languages and their abbreviations. **65**

### 2 Press AUDIO or ▲ / ▼ while the audio setting is displayed on the TV screen.

**AUDIO**  
 Each time you press the AUDIO button or the ▲ / ▼ buttons, the audio settings included on the disc change.

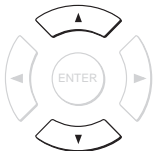

To turn off the audio setting display, press the CLEAR button.

### ■ Selecting sound channels of VIDEO CDs

You can switch left and right channels by pressing the **AUDIO** button repeatedly during playback.



#### Notes

- When you turn on the DVD player or replace a disc, player returns to the initial default setting **61**.
- If you select a sound track which is not included on the disc, the DVD player plays a prior sound track programmed on the disc.
- Some discs allow you to change audio selections only via the disc menu. If this is the case, press the MENU button and choose the appropriate language from the selections on the disc menu.

## ■ Output sound conversion table

| Input \ Output |                            | BITSTREAM/PCM jack                     |           | ANALOG AUDIO OUT Jacks |
|----------------|----------------------------|--|-----------|------------------------|
|                |                            | "Digital Output" <b>56</b> / <b>59</b> |           |                        |
|                |                            | "Bitstream"                            | "PCM"     |                        |
| DVD video disc | Dolby Digital              | Bitstream                              | PCM       | ○                      |
|                | Linear PCM                 | PCM                                    | PCM       | ○                      |
|                | DTS                        | Bitstream                              | Bitstream | —                      |
|                | MPEG1, MPEG2               | Bitstream                              | PCM       | ○                      |
| VIDEO CD       | MPEG1                      | PCM                                    | PCM       | ○                      |
| Audio CD       | Linear PCM 44.1 kHz/16 bit | PCM                                    | PCM       | ○                      |
|                | DTS                        | Bitstream                              | Bitstream | Noise                  |
|                | MP3                        | PCM                                    | PCM       | ○                      |

 : 3D sound enhancement can function.

- Signals of 96kHz from the BITSTREAM/PCM jack are depressed to 48 kHz by down sampling process when:
  - "3D" is selected. **39**
  - "PCM Down Sampling" is set to "On." **59**
  - a copyright protected disc is played.
- Quantization bit of signals of 20 bit or higher which is output from the BITSTREAM/PCM jack is 16 bit if they are in a copyright protected disc.

# Quick control

Simple use of a single button and the cursor control enables you to direct your playback, without manipulating many actual buttons.

- **Using the Virtual Remote Control - V-REMOTE -**
- **Selecting the Playback Function - QUICK -**
- **Accessing Features - NAVI -**

# Using the Virtual Remote Control

## - V-REMOTE -

Pressing one button can display a graphics based on-screen remote control that allows you to control playback as if you were doing it from the actual remote control.

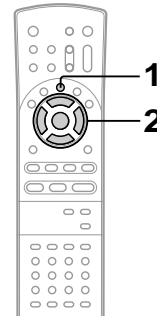

DVD-V VCD  
CD

### Using the virtual remote control

**1 During playback, press V-REMOTE.**  
 V-REMOTE The graphic remote control (Virtual Remote) appears.  
 For the meaning of each icon, see right.

e.g. DVD-V

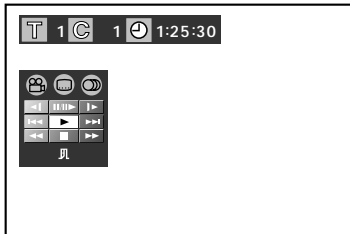

**2 Press ▲/▼/◀/▶ to select the icon, and press ENTER.**

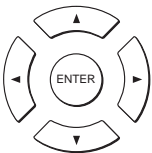

■ **To turn off the Virtual Remote**

Press V-REMOTE.

V-REMOTE



**Note**

Some discs may not permit this operation.

■ **Icons and features**

See the pages in [ ] for details on the features.

| Icon | Function  | Page |
|------|---|------|
| T*   | Current title/track number  | -    |
| C*   | Current chapter number  | -    |
| ⌚*   | Elapsed time of the current title/track                             | -    |
| 🔊**  | Audio setting   | [42] |
| 🗣️** | Subtitle setting  | [41] |
| 🎬**  | Angle setting   | [40] |
| ⏮️   | Reverse slow motion playback  | [29] |
| ⏸️   | Pause / Frame by frame playback                                     | [28] |
| ⏪    | To begin slow motion playback                                       | [29] |
| ⏮️   | Playback starts from the beginning of the current chapter or track. | [31] |
| ▶️   | Normal playback   | [26] |
| ⏭️   | To locate succeeding chapters or tracks.                            | [31] |
| ⏮️   | Fast reverse playback   | [28] |
| ■    | To stop playback.   | [27] |
| ⏭️   | Fast forward playback   | [28] |
| 🔌    | To turn off the Virtual Remote.                                     |      |

\* You can access a desired location. After step 2, perform the steps below:

T / C : steps 3 to 5 on [31]

⌚ : steps 2 and 3 on [34]

\*\* After step 2, a sub menu will appear. Perform step 2 on the page in [ ].

# Selecting the Playback Function - QUICK -

Pressing one button can display a list of playback functions which are relevant to your current playback mode. You can check and modify them from the list.

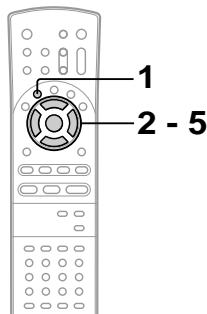

## DVD-V VCD CD Selecting the playback function

### 1 During playback, press QUICK.



The following on-screen display appears. (The actual display will vary depending on the playback status.)

e.g. **DVD-V**

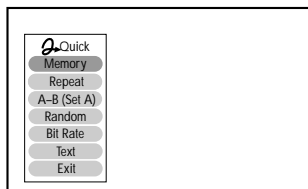

### 2 Press ▲ / ▼ to select a desired item.

e.g. To change the repeat mode:

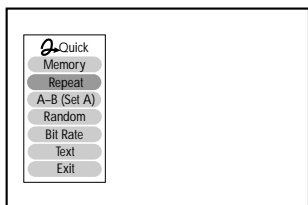

### 3 Press ENTER.

e.g. The mode menu appears.

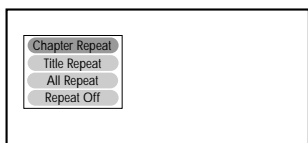

### 4 Press ▲ / ▼ to change the setting.

e.g. To select the title repeat mode:

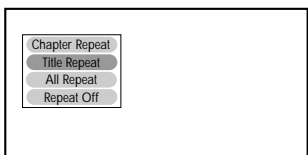
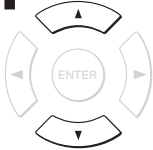

### 5 Press ENTER.



The on-screen display disappears and playback will resume according to your selection.

#### Quick menu

- Memory : To program memory playback. **[36]**
- Repeat : To select the repeat playback mode. For the mode selections, see page **[35]**.
- A-B (Set A) : At the beginning of a segment you want to repeat, press the ENTER button. Then at the end of the segment, press the ENTER button again. The segment is played repeatedly. **[35]**
- Random : To select the random playback mode. For the mode selections, see page **[37]**.
- Bit Rate : To activate the bitrate display. (Bit rate: data transfer rate (Mbit/s) Refers to the amount of picture, sound and subtitle data in the DVD video disc transferred per second. The larger the value, the more data processed, but this does not necessarily insure better picture quality.)
- Text : To activate the Text display. Text display: Displays DVD-Text data or CD-Text data if included on the disc. (Some content on the disc may not be displayed properly depending on the disc.)
- Exit : To quit the on-screen display.

#### Note

Pressing the QUICK button again also exits the on-screen display.

# Accessing Features - NAVI -

The NAVI menu provides an icon based display from which you can easily access key playback function or setting.

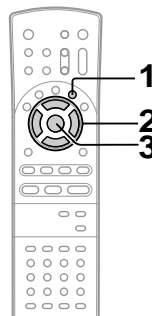

DVD-V VCD  
CD

## NAVI menu items

### 1 Press NAVI.



The NAVI menu appears.

e.g. DVD-V

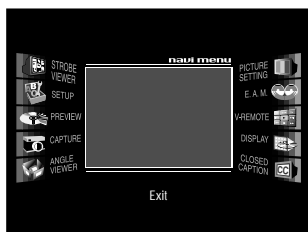

### 2 Press ▲/▼/◀/▶ to select a desired feature icon.

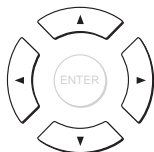

For details on each feature, refer to the list on the next page.

### 3 Press ENTER.



Selection details appears.

### 4 Refer to the list on the next page and follow the instructions detailed on subsequent pages.

### ■ To exit the NAVI menu

Press NAVI.





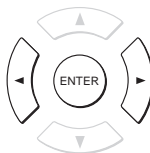







Alternatively press ◀/▶ to remove the highlight from an icon to the center position, and press ENTER.



### Note

Depending on the disc, some features cannot be accessed.

## Navi menu selections

|   |                        |  |           |
|---|------------------------|--|-----------|
|    | <b>STROBE VIEWER</b>   | You can divide a desired scene into stop action frames for careful analysis.                                   | <b>50</b> |
|    | <b>SETUP</b>           | You can change the default settings to customize performance to your preference.                               | <b>56</b> |
|    | <b>PREVIEW</b>         | You can display thumbnail views of the first scenes of titles or chapters and select a preferred one.          | <b>50</b> |
|    | <b>CAPTURE</b>         | You can sample a scene from a playback picture and transform it into a background picture.                     | <b>51</b> |
|  | <b>ANGLE VIEWER</b>    | You can display all camera angles simultaneously and select a preferred one from them.                         | <b>51</b> |
|  | <b>PICTURE SETTING</b> | You can fine tune picture quality and store up to 3 custom picture settings in the memory of the DVD player.   | <b>52</b> |
|  | <b>E.A.M.</b>          | You can easily switch a preferred audio enhancement.   | <b>39</b> |
|  | <b>V-REMOTE</b>        | You can control key playback functions using the graphics based on-screen remote control.                      | <b>46</b> |
|  | <b>DISPLAY</b>         | You can view information about a disc and its operational status on the TV screen.                             | <b>53</b> |
|  | <b>CLOSED CAPTION</b>  | You can display closed captions included on a DVD disc without connecting a closed caption decoder to your TV. | <b>53</b> |

# Accessing Features - NAVI - (continued)

## NAVI menu items

### STROBE VIEWER



You can divide a desired scene into stop action frames for careful analysis.

After selecting this icon and pressing ENTER, the following on-screen display appears:

e.g.

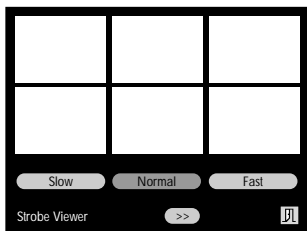

1 Press ▲/▼/◀/▶ to select.

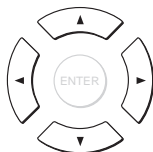

- Slow: Still pictures at shorter intervals.
- Normal: Still pictures at normal intervals.
- Fast: Still pictures at longer intervals.
- >>: To view the next series of 6 pictures.
- ⏏: To quit the on-screen display.

2 Press ENTER.



**Note**

Some discs or scenes may not permit this operation.

### PREVIEW



You can display thumbnail views of the first scenes of titles or chapters and select a preferred one.

After selecting this icon and pressing ENTER, the following on-screen display appears:

e.g.

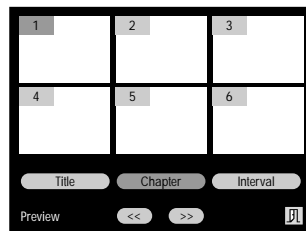

1 Press ▲/▼/◀/▶ to select.

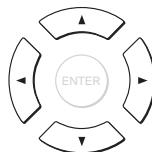

- 1 - 6: To locate the scene.
- Title: To display the first scenes of titles (1 to 6).
- Chapter: To display the first scenes of chapters (1 to 6).
- Interval: To display scenes at intervals of about 10 minutes apart.
- <<: To go to the previous page.
- >>: To go to the next page.
- ⏏: To quit the on-screen display.

2 Press ENTER.



**Notes**

- Some discs or scenes may not permit this operation.
- Some items may not be selected depending on the disc or scene.
- Some of the first scenes may not be picked up depending on the disc.



### CAPTURE



You can sample a scene from a playback picture and transform it into a background picture.

After selecting this icon and pressing ENTER, the following on-screen display appears:

e.g.

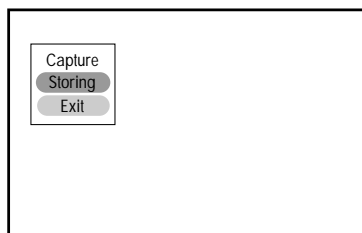

- 1 Pause playback at a scene you want to capture.
- 2 Press ▲ / ▼ to select.

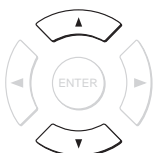

Storing: To sample and store the current picture in the player memory.  
Exit: To quit the on-screen display.

- 3 Press ENTER.



The stored picture will be displayed as a background picture when the player is in the stop mode. It is necessary to confirm this process via the setup menu **62**.

#### Notes

- You can store only one picture. Storing a new picture will erase the old one.
- No other operations are permitted while in the process of sampling and storage of background picture.
- Some discs or scenes may not permit this operation.

### ANGLE VIEWER



You can display all camera angles simultaneously and select a preferred one from them.

After selecting this icon and pressing ENTER, the following on-screen display appears:

e.g.

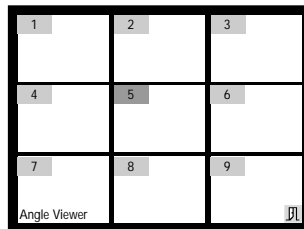

When the scene contains 9 camera angles:

- 1 Press ▲ / ▼ / ◀ / ▶ to select.

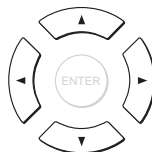

1-9 : To select the camera angle.  
[ENTER] : To quit the on-screen display.

- 2 Press ENTER.



#### Note

Some discs or scenes may not permit this operation.

## Accessing Features - NAVI - (continued)

### NAVI menu items

#### PICTURE SETTING



You can fine tune picture quality and store up to 3 custom picture settings in the memory of the DVD player.

After selecting this icon and pressing ENTER, the following on-screen display appears:

e.g.



- 1 Press ▲/▼ to select, and press ENTER.

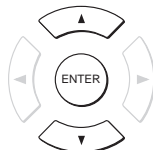

1, 2, 3: Select the desired custom memory number. (Follow steps 2 to 4 below.)

- 2 Press ▲/▼ to select the element.

e.g. When you select "Color":

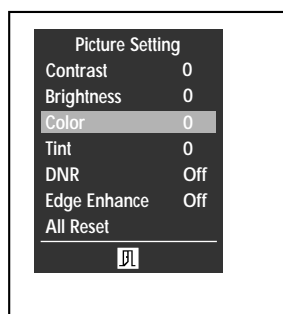

- 3 Press ENTER.

The sub menu appears.

- 4 Press ◀/▶ to adjust the value, and press ENTER.

e.g.



Contrast : -7 (Lower) to +7 (Higher)  
 Brightness : -7 (Darker) to +7 (Brighter)  
 Color: -7 (Duller) to +7 (Brighter)  
 Tint : -7 (Redder) to +7 (Greener)

DNR\*1 : On / Off

Edge Enhance\*2 : On / Off

All Reset : To restore all the elements to the normal setting. A message will appear. Follow the procedure displayed on-screen.

\*1: DNR: Digital Noise Reduction.  
 To view a picture with less video noise.

#### Notes

- Actual picture enhancement may vary depending on the quality of the disc.
- While the DNR feature can provide additional improvement in the reduction of noise in the video signal, it may produce undesirable picture artifacts on some discs.
- Depending on the disc, some kinds of picture details may be lost by the picture enhancement.

\*2: To enhance picture edges.

#### Note

The Tint adjustment is not available when connecting to a TV via the component video jacks (Y, P<sub>B</sub>, P<sub>R</sub>).

#### ■ Using the remote control to adjust the brightness

Press BRIGHTNESS (+/-).

Each time you press the button, the brightness changes.

#### ■ Using the remote control to select the DNR feature

Press DNR.

Each time you press the button, the feature turns on or off.

**DISPLAY**

You can view information about a disc and its operational status on the TV screen.

After selecting this icon and pressing ENTER, the following on-screen display appears:

e.g.

```
Title : 1
Chapter : 23
Time : 1:23:45
Audio : ENG 1  D 2CH
Subtitle : ENG 1 On
Angle : 1/3
E.A.M. : Normal
Zoom : Off
Chapter repeat
```

To quit the on-screen display, press **ENTER**.

**Note**

Some discs or scenes may not permit this operation.

**CLOSED CAPTION**

You can display closed captions included on a DVD disc without connecting a closed caption decoder to your TV.

After selecting this icon and pressing ENTER, the following on-screen display appears:

e.g.



- 1 Press **▲/▼** to select.

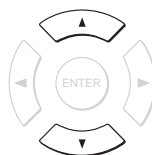

On : To display closed captions.  
Off: To disable closed captions.

- 2 Press **ENTER**.

**Notes**

- While you are using on-screen displays (including the above one), you cannot view closed captions.
- When "On" is selected, some displays such as "▶" may be disabled.

# Function Setup

---

You can change the default settings to customize performance to your preference.

- **Customizing the Function Settings**
- **Table of Languages**

# Customizing the Function Settings

You can change the default settings to customize performance to your preference.

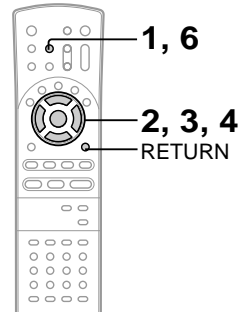

DVD-V VCD CD **Setting procedure**

**1 Press SETUP during stop.**  
 SETUP The following on-screen display appears.

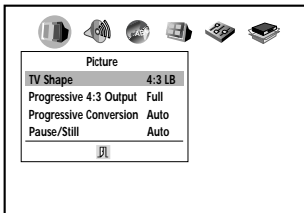

**2 Press ◀/▶ to select a symbol for the setting you want to change.**

(See the next page.)

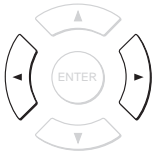

Picture performance settings



Output sound settings



Language settings



Display settings



Operational settings



Initializing

**3 Press ▲/▼ to select the setting you want to change, then press ENTER.**

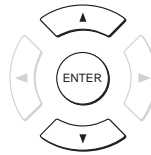

**4 Change the selection by ▲/▼ or other buttons, by referring to the corresponding pages [58], then press ENTER.**

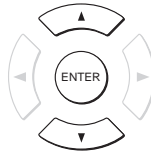

**5 Repeat steps 3 and 4 to change other settings.**

To select another operation, go back to step 2.

**6 Press SETUP.**  
 SETUP The on-screen display disappears.









■ **To return to the previous display**  
 Press RETURN.



**Notes**

- The on-screen display disappears also when you select “” and press the ENTER button.
- The SETUP button can function even during normal playback, however some operations may be inaccessible, and a message will appear. In this case, try again after playback is stopped.

| Setting  |                        | Details         | Page  |    |
|--|------------------------|-----------------|---|----|
|    | TV Shape               | DVD-V           | To select a picture size according to the aspect ratio of your TV.  | 58 |
|  | Progressive 4:3 Output | DVD-V<br>VCD    | To select the video output of pictures recorded in 4:3 format. (Only when connected to a PROGRESSIVE TV.)   | 58 |
|  | Progressive Conversion | DVD-V           | To select the system of output signal. (Only when connected to a PROGRESSIVE TV.)   | 58 |
|  | Pause/Still            | DVD-V           | To select the resolution of still pictures. (Field/Frame)   | 58 |
|    | PCM Down Sampling      | DVD-V           | To select a sound processing option according to performance of the connected equipment. (Only when the BITSTREAM/PCM (DIGITAL) AUDIO OUT jack is connected.) | 59 |
|  | Digital Output         | DVD-V VCD<br>CD | To select an output sound format corresponding to your system connection.   | 59 |
|  | Dynamic Range Control  | DVD-V           | To turn on or off a function that makes faint sounds easier to hear even if you lower the volume during late hours playback.                                  | 59 |
|  | Karaoke Vocal          | DVD-V           | To turn on or off the vocal output during DVD KARAOKE disc playback.  | 60 |
|    | On-Screen Language     | DVD-V VCD<br>CD | To select a preferred language for on-screen displays.  | 60 |
|  | Disc Menu Language     | DVD-V           | To select a preferred language for disc menus.  | 60 |
|  | Audio Language         | DVD-V           | To select a preferred language for the sound track.   | 61 |
|  | Subtitle Language      | DVD-V           | To select a preferred language for subtitles.   | 61 |
|  | On-Screen Displays     | DVD-V VCD<br>CD | To turn on or de-activate the operational status display on the TV screen.  | 62 |
|  | Background             | DVD-V VCD<br>CD | To select the background color or background picture.   | 62 |
|  | Screen Saver           | DVD-V           | To turn the screen saver on or off.   | 62 |
|  | Parental Lock          | DVD-V           | To turn the parental lock function on or off.   | 62 |
|  | Remote Confirmation    | DVD-V VCD<br>CD | To turn on or off the confirmation beeper announcing when each remote command received.   | 64 |
|  | Title Stop             | DVD-V           | To turn on or off a feature that automatically stops playback after a title has been viewed.  | 64 |
|  | PBC                    | VCD             | To use the menu screen when playing a PBC-controllable VIDEO CD.  | 64 |
|  | Priority Contents      |                 | To select the playback priority between JPEG (picture) files and MP3 (audio) files.   | 64 |
|  | Initialize             | DVD-V VCD<br>CD | To restore all settings to the factory set.   | 64 |

# Customizing the Function Settings (continued)

## Setting details

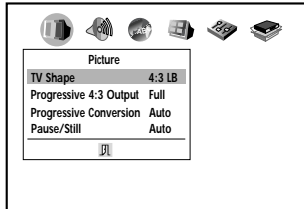
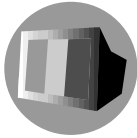

### TV Shape DVD-V

**4:3 Letterbox:** Select when a standard 4:3 TV is connected. Displays theatrical images with masking bars above and below the picture.



**4:3 Normal:** Select when a standard 4:3 TV is connected. Displays pictures cropped to fill your TV screen. Either or both sides of the picture are cut off.



**16:9 Widescreen:** Select when a 16:9 wide TV is connected.

#### Notes

- The displayable picture size is preset on the DVD video disc. Therefore, the playback picture of some DVD video discs may not conform to the picture size you select.
- When you play DVD video discs recorded in the 4:3 picture size only, the playback picture always appears in the 4:3 picture size regardless of the TV shape setting.
- If you select "16:9 Widescreen" and you own a 4:3 TV set, the DVD playback picture will be horizontally distorted during playback. Images will appear to be horizontally compressed. Always be sure that your TV shape conforms to the actual TV in use.

### Progressive 4:3 Output DVD-V VCD

Select the video output of pictures recorded in 4:3 format. (Only when connected to a PROGRESSIVE TV.)

**Full:** Displays pictures expanded horizontally to fill the 16:9 screen.

**4:3:** Displays images in 4:3 aspect ratio with masking bars to the left and right of the picture. (Select this option when a connected TV cannot select 4:3 picture size. However, subtitles or menus may not work properly.)

### Progressive Conversion DVD-V

There are two types of source content in pictures recorded in DVD video discs: film content (pictures recorded from films at 24 frames per second) and video content (video signals recorded at 30 frames per second). Make this selection according to the type of content being viewed.

- Auto:** Select this position normally. The DVD player automatically detects source content, film or video, of playback source, and converts that signal to the progressive output format in an appropriate method.
- Video:** The DVD player filters video signal, and converts it to the progressive output format appropriately. Suitable for playback of video content pictures.
- Film:** The DVD player converts film content pictures to the progressive output format appropriately. Suitable for playback of film content pictures. The progressive output feature will be most effective under this selection.

#### Note

Depending on the disc, pictures may be cut off or doubled. In this case, select "Video."

### Pause/Still DVD-V

**Auto:** For normal use. Still and fast motion images can be paused.

**Frame:** The resolution of still pictures is improved, so that you can make a motionless picture more clearer when you pause it.

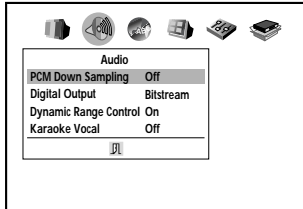

### PCM Down Sampling DVD-V

Make this selection only when you use your audio equipment (e.g. receiver) connecting to the DVD player via the BITSTREAM/PCM (DIGITAL) AUDIO OUT jack.

According to performance of your connected receiver, select a sound processing option for playback of a disc that contains high frequency signals (sampling frequency 96 kHz).

- Off:** Select when your connected receiver processes high frequency signals of 96 kHz. The DVD player outputs these signals as they are on the disc.
- On:** Select when your connected receiver does not process high frequency signals of 96 kHz. The DVD player outputs these signals in a disc depressing the frequencies to 48 kHz.

#### Notes

- Regardless of this setting, high frequency signals on a DVD disc are down-converted to 48 kHz if that disc is copy protected.
- If you select "Off" because your connected receiver does not process high frequency signals of 96 kHz, you will not hear output sound from those signals.

### Digital Output DVD-V | VCD | CD

Select the output sound format corresponding to your system connection.

For details of sound recording systems, see [43](#).

**Bitstream:** Select when connected to an amplifier equipped with a Dolby Digital, DTS, MPEG1 or MPEG2 decoder. [21](#) [22](#)  
The DVD player outputs digital audio information in the bitstream format when you play a DVD video disc recorded on the Dolby Digital, DTS, MPEG1 or MPEG2 recording system.

**PCM:** Select when connected to a 2 channel digital stereo amplifier. [23](#)  
The DVD player outputs sounds in the PCM 2ch format when you play a DVD video disc recorded on the Dolby Digital, MPEG1 or MPEG2 recording system.

#### Note

When you make a connection to a TV, or Dolby Surround Pro Logic or stereo system via the analog audio jacks, select "Bitstream" or "PCM."

### Dynamic Range Control DVD-V

- Off:** Full dynamic range is maintained.
- On:** Dynamic range is reduced.

#### Notes

- This function works only during playback of Dolby Digital recorded discs.
- The level of Dynamic Range Reduction may differ depending on the DVD disc.



# Customizing the Function Settings (continued)

## Setting details

### Karaoke Vocal DVD-V

Off: The primary vocal is not output.

On: The primary vocal is output when it is recorded on the disc.

#### Notes

- The vocal output feature is used during playback of Dolby Digital (multi-channel) recorded DVD KARAOKE discs. This feature allows you to turn off vocal audio tracks, or restore them for background accompaniment.
- When playing KARAOKE, connect appropriate audio equipment such as an amplifier to the DVD player.

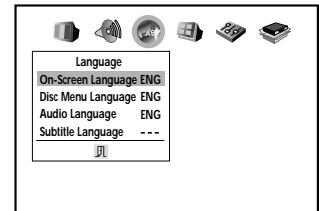

### On-Screen Language DVD-V VCD CD

English: To view on-screen displays in English.

Français: To view on-screen displays in French.

Español: To view on-screen displays in Spanish.

### Disc Menu Language DVD-V

English: To display disc menus in English.

French: To display disc menus in French.

Spanish: To display disc menus in Spanish.

Others: To make a further choice.

After pressing the ENTER button, follow steps 1) - 4) below.

- 1) Obtain the abbreviation of the preferred language from the list **65**.
- 2) Select the first character by pressing the ▲ / ▼ buttons.
- 3) Press the ◀ / ▶ buttons to shift and select the second character by pressing the ▲ / ▼ buttons.

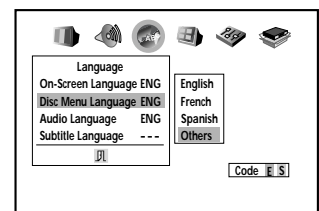

- 4) Press the ENTER button.

#### Note

Some DVD video discs may not include your pre-selected language. In this case, the DVD player automatically displays disc menus consistent with the disc's initial language setting.

### Audio Language DVD-V

English: To play sound tracks in English.  
 French: To play sound tracks in French.  
 Spanish: To play sound tracks in Spanish.  
 Others: To make a further choice.  
 After pressing the ENTER button, follow steps 1) - 4) below.

- 1) Obtain the abbreviation of the preferred language from the list **65**.
- 2) Select the first character by pressing the ▲ / ▼ buttons.
- 3) Press the ◀ / ▶ buttons to shift and select the second character by pressing the ▲ / ▼ buttons.

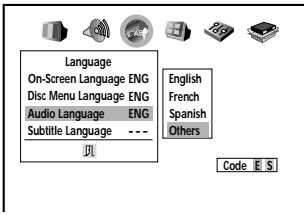

4) Press the ENTER button.

**Note**  
 Some DVD video discs may be played in a different language than you selected. A prior language may be programmed on the disc.

### Subtitle Language DVD-V

English: To display subtitles in English.  
 French: To display subtitles in French.  
 Spanish: To display subtitles in Spanish.  
 No Subtitle: To disable subtitles.  
 Others: To make a further choice.  
 After pressing the ENTER button, follow steps 1) - 4) below.

- 1) Obtain the abbreviation of the preferred language from the list **65**.
- 2) Select the first character by pressing the ▲ / ▼ buttons.

3) Press the ◀ / ▶ buttons to shift and select the second character by pressing the ▲ / ▼ buttons.

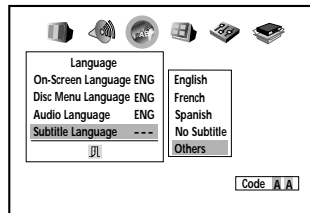

4) Press the ENTER button.

**Notes**

- Some DVD video discs may be set to display subtitles in a different language than you selected. A prior subtitle language may be programmed on the disc.
- Some DVD video discs allow you to change subtitle selections only via the disc menu. If this is the case, press the MENU button and choose the appropriate subtitle language from the selection on the disc menu.

# Customizing the Function Settings (continued)

## Setting details

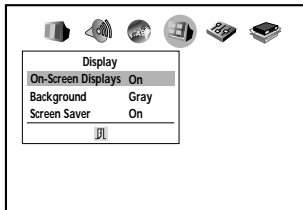

### On-Screen Displays DVD-V VCD CD

Off: Operational modes (e.g. "□□", "▶▶") are not displayed.

On: Operational modes (e.g. "□□", "▶▶") are displayed on-screen.

### Background DVD-V VCD CD

Blue: Blue background.

Gray: Gray background.

Capture: To use a picture you sampled and stored in the memory using the Capture feature **51** as a background.

Jacket: To use the jacket picture included on some discs as a background. If it is not included, a gray background will be substituted.

### Screen Saver DVD-V

Off: The screen saver is disengaged.

On: The screen saver operates.

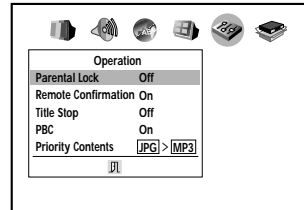
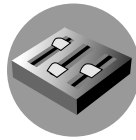

### Parental Lock DVD-V

DVD video discs equipped with the parental lock function are rated according to their content. The contents allowed by a parental lock level and the way a DVD video disc can be controlled may vary from disc to disc. For example, if the disc allowed you could edit out violent scenes unsuitable for children and replace them with more suitable scenes, or lock out playback of the disc altogether.

- DVD video discs may or may not respond to the parental lock settings. This is not a defect in the DVD player. Make sure this function works with your DVD video discs.

Off: The parental lock feature does not function. After pressing the ENTER button, follow step 1) below.

On: To activate the parental lock feature or change the settings. After pressing the ENTER button, follow steps 1) - 3) below.

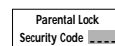

1) Press the number buttons to create a personal 4-digit security code, then press the ENTER button.

If you make a mistake before pressing the ENTER button, press the CLEAR button and enter your 4-digit security code again.

2) Enter the code of a country/area whose standards were used to rate the DVD video disc, referring to the list below.

| Country/Area       | Code |
|--------------------|------|
| AUSTRALIA          | AU   |
| BELGIUM            | BE   |
| CANADA             | CA   |
| CHINA              | CN   |
| CHINA HONG KONG    | HK   |
| DENMARK            | DK   |
| FINLAND            | FI   |
| FRANCE             | FR   |
| GERMANY            | DE   |
| INDONESIA          | ID   |
| ITALY              | IT   |
| JAPAN              | JP   |
| MALAYSIA           | MY   |
| NETHERLANDS        | NL   |
| NORWAY             | NO   |
| PHILIPPINES        | PH   |
| RUSSIAN FEDERATION | RU   |
| SINGAPORE          | SG   |
| SPAIN              | ES   |
| SWEDEN             | SE   |
| SWITZERLAND        | CH   |
| TAIWAN             | TW   |
| THAILAND           | TH   |
| UNITED KINGDOM     | GB   |
| UNITED STATES      | US   |

- Select the first character by pressing the ▲ / ▼ buttons.
- Press the ◀ / ▶ buttons to shift and select the second character by pressing the ▲ / ▼ buttons.
- Press the ENTER button.

3) Press the ▲ / ▼ buttons to select the parental lock level, then press the ENTER button.

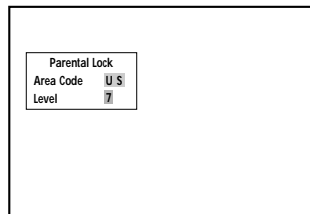

You cannot play DVD video discs rated higher than the level you selected unless you cancel the parental lock function. For example, when you select level 7, discs rated higher than level 7 are locked out and cannot be played.

The parental lock level is equivalent to the following USA movie ratings.  
 Level 7: NC-17  
 Level 6: R  
 Level 4: PG 13  
 Level 3: PG  
 Level 1: G

The parental lock levels for other countries/areas than U.S. are included for future use. Check the appropriate parental lock level when you buy a DVD video disc equipped with the parental lock feature in the future.

■ **To change the parental lock level**  
 Follow steps 1) - 3).

■ **To change your 4-digit security code**

1) After selecting "On" or "Off," press the STOP button four times, then press the ENTER button.

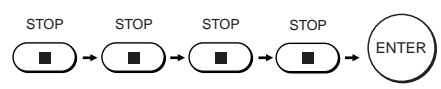

- The 4-digit security code is cleared.
- Press the number buttons to create a new 4-digit security code.
  - Press the ENTER button.

**Note**  
 After making the "Parental Lock" setting, the on-screen display will disappear. To make other settings, press the SETUP button again to display them.

# Customizing the Function Settings (continued)

## Setting details

### Remote Confirmation DVD-V | VCD | CD

Off: The beeper does not sound.

On: The beeper sounds with each remote operation.

### Title Stop DVD-V

Off: The DVD player continues after playback of a title is completed.

On: The DVD player stops after playback of a title is completed.

### PBC VCD

Off: When playing a VIDEO CD without using the menu.

On: To use the menu when playing a PBC-featured VIDEO CD.

### Priority Contents

To select the playback priority between JPEG (picture) files and MP3 (audio) files.

JPG > MP3: JPEG files take priority over MP3 files.

MP3 > JPG: MP3 files take priority over JPEG files.

Refer to the separate booklet "Digital Photo Viewer" on how to play a disc containing JPEG format files.

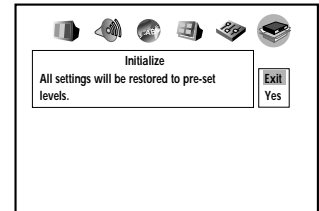
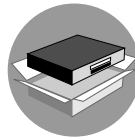

### Initialize DVD-V | VCD | CD

To restore all settings to the factory set.

- 1) Press the **▲** / **▼** buttons to select "Yes," and press the **ENTER** button.

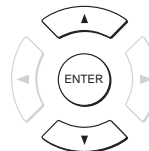

- 2) Read the message, and if you really want to restore all settings, press the **▲** / **▼** buttons to select "Yes," and press the **ENTER** button.

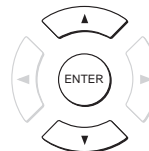

The message of completion appears.

#### Note

The "Parental Lock" setting is not restored to the factory set.

# Table of Languages

**Table of languages and their abbreviations**

| Abbreviation | Language              | Abbreviation | Language         | Abbreviation | Language       |
|--------------|-----------------------|--------------|------------------|--------------|----------------|
| ---          | No alternate language | GN           | Guarani          | PT           | Portuguese     |
| CHI (ZH)     | Chinese               | GU           | Gujarati         | QU           | Quechua        |
| DUT (NL)     | Dutch                 | HA           | Hausa            | RM           | Rhaeto-Romance |
| ENG (EN)     | English               | HI           | Hindi            | RN           | Kirundi        |
| FRE (FR)     | French                | HR           | Croatian         | RO           | Rumanian       |
| GER (DE)     | German                | HU           | Hungarian        | RU           | Russian        |
| ITA (IT)     | Italian               | HY           | Armenian         | RW           | Kinyarwanda    |
| JPN (JA)     | Japanese              | IA           | Interlingua      | SA           | Sanskrit       |
| KOR (KO)     | Korean                | IE           | Interlingue      | SD           | Sindhi         |
| MAY (MS)     | Malay                 | IK           | Inupiak          | SG           | Sango          |
| SPA (ES)     | Spanish               | IN           | Indonesian       | SH           | Serbo-Croatian |
| AA           | Afar                  | IS           | Icelandic        | SI           | Singhalese     |
| AB           | Abkhazian             | IW           | Hebrew           | SK           | Slovak         |
| AF           | Afrikaans             | JI           | Yiddish          | SL           | Slovenian      |
| AM           | Amharic               | JW           | Javanese         | SM           | Samoan         |
| AR           | Arabic                | KA           | Georgian         | SN           | Shona          |
| AS           | Assamese              | KK           | Kazakh           | SO           | Somali         |
| AY           | Aymara                | KL           | Greenlandic      | SQ           | Albanian       |
| AZ           | Azerbaijani           | KM           | Cambodian        | SR           | Serbian        |
| BA           | Bashkir               | KN           | Kannada          | SS           | Siswati        |
| BE           | Belorussian           | KS           | Kashmiri         | ST           | Sesotho        |
| BG           | Bulgarian             | KU           | Kurdish          | SU           | Sundanese      |
| BH           | Bihari                | KY           | Kirghiz          | SV           | Swedish        |
| BI           | Bislama               | LA           | Latin            | SW           | Swahili        |
| BN           | Bengali, Bangla       | LN           | Lingala          | TA           | Tamil          |
| BO           | Tibetan               | LO           | Laotian          | TE           | Telugu         |
| BR           | Breton                | LT           | Lithuanian       | TG           | Tajik          |
| CA           | Catalan               | LV           | Latvian, Lettish | TH           | Thai           |
| CO           | Corsican              | MG           | Malagasy         | TI           | Tigrinya       |
| CS           | Czech                 | MI           | Maori            | TK           | Turkmen        |
| CY           | Welsh                 | MK           | Macedonian       | TL           | Tagalog        |
| DA           | Danish                | ML           | Malayalam        | TN           | Setswana       |
| DZ           | Bhutani               | MN           | Mongolian        | TO           | Tongan         |
| EL           | Greek                 | MO           | Moldavian        | TR           | Turkish        |
| EO           | Esperanto             | MR           | Marathi          | TS           | Tsonga         |
| ET           | Estonian              | MT           | Maltese          | TT           | Tatar          |
| EU           | Basque                | MY           | Burmese          | TW           | Twi            |
| FA           | Persian               | NA           | Nauru            | UK           | Ukrainian      |
| FI           | Finnish               | NE           | Nepali           | UR           | Urdu           |
| FJ           | Fiji                  | NO           | Norwegian        | UZ           | Uzbek          |
| FO           | Faroese               | OC           | Occitan          | VI           | Vietnamese     |
| FY           | Frisian               | OM           | (Afan) Oromo     | VO           | Volapük        |
| GA           | Irish                 | OR           | Oriya            | WO           | Wolof          |
| GD           | Scottish Gaelic       | PA           | Panjabi          | XH           | Xhosa          |
| GL           | Galician              | PL           | Polish           | YO           | Yoruba         |
|              |                       | PS           | Pashto, Pushto   | ZU           | Zulu           |

# Others

- Before Calling Service Personnel
- Specifications
- LIMITED WARRANTY DVD PLAYER

## Before Calling Service Personnel

Check the following guide for the possible cause of a problem before contacting service.

### Symptoms and correction

| Symptom  | Cause   | Correction   | Page                 |
|--|---|--|----------------------|
| No power.  | <ul style="list-style-type: none"> <li>The power plug is disconnected.</li> </ul>   | <ul style="list-style-type: none"> <li>Connect the power plug securely into the wall outlet.</li> </ul>  | <b>18</b>            |
| The DVD player turned off by itself.                                   | <ul style="list-style-type: none"> <li>The automatic power off function turned the unit off.</li> </ul>   | <ul style="list-style-type: none"> <li>Press the PLAY button.</li> </ul>   | <b>27</b>            |
| No picture.  | <ul style="list-style-type: none"> <li>The TV is not set to receive DVD signal output.</li> </ul>   | <ul style="list-style-type: none"> <li>Select the appropriate video input mode on the TV so the picture from the DVD player appears on the TV screen.</li> </ul>   | <b>26</b>            |
|  | <ul style="list-style-type: none"> <li>The video cable is not connected securely.</li> </ul>  | <ul style="list-style-type: none"> <li>Connect the video cable securely into the appropriate jacks.</li> </ul>   | <b>18, 19</b>        |
| No sound.  | <ul style="list-style-type: none"> <li>The equipment connected with the audio cable is not set to receive DVD signal output.</li> </ul>                         | <ul style="list-style-type: none"> <li>Select the correct input mode of the audio receiver so you can listen to the sound from the DVD player.</li> </ul>  | <b>26</b>            |
|  | <ul style="list-style-type: none"> <li>The audio cable is not connected securely.</li> </ul>  | <ul style="list-style-type: none"> <li>Connect the audio cable securely into the appropriate jacks.</li> </ul>   | <b>18-23</b>         |
|  | <ul style="list-style-type: none"> <li>The audio receiver or TV is turned off.</li> </ul>   | <ul style="list-style-type: none"> <li>Turn on the equipment connected with the audio cable.</li> </ul>  | <b>26</b>            |
|  | <ul style="list-style-type: none"> <li>The setting of output sound format is incorrect.</li> </ul>  | <ul style="list-style-type: none"> <li>Select the proper audio setting.</li> </ul>   | <b>42, 56<br/>59</b> |
| The playback picture has occasional distortion.                        | <ul style="list-style-type: none"> <li>The disc is dirty.</li> </ul>  | <ul style="list-style-type: none"> <li>Eject the disc and clean it.</li> </ul>   | <b>9</b>             |
|  | <ul style="list-style-type: none"> <li>It is in fast forward or fast reverse playback.</li> </ul>   | <ul style="list-style-type: none"> <li>Sometimes a small amount of picture distortion may appear. This is not a malfunction.</li> </ul>  | —                    |
| Brightness is unstable or noises are present in the playback pictures. | <ul style="list-style-type: none"> <li>The effect of copy protection.</li> </ul>  | <ul style="list-style-type: none"> <li>Connect the DVD player directly to the TV. Avoid connecting the DVD player to a VCR or TV/VCR combination.</li> </ul>   | <b>18</b>            |
| The DVD player does not start playback.                                | <ul style="list-style-type: none"> <li>No disc is inserted.</li> </ul>  | <ul style="list-style-type: none"> <li>Insert a disc.</li> </ul>   | <b>26</b>            |
|  | <ul style="list-style-type: none"> <li>An unplayable disc is inserted.</li> </ul>   | <ul style="list-style-type: none"> <li>Insert a playable disc. (Check the disc type.)</li> </ul>   | <b>10</b>            |
|  | <ul style="list-style-type: none"> <li>The disc is placed upside down.</li> </ul>   | <ul style="list-style-type: none"> <li>Place the disc with the playback side down.</li> </ul>  | <b>26</b>            |
|  | <ul style="list-style-type: none"> <li>The disc is not placed within the guide.</li> </ul>  | <ul style="list-style-type: none"> <li>Place the disc correctly inside the guide on the disc tray.</li> </ul>  | <b>26</b>            |
|  | <ul style="list-style-type: none"> <li>The disc is dirty.</li> </ul>  | <ul style="list-style-type: none"> <li>Clean the disc.</li> </ul>  | <b>9</b>             |
|  | <ul style="list-style-type: none"> <li>The parental lock function is set.</li> </ul>  | <ul style="list-style-type: none"> <li>Cancel the parental lock function or change the parental lock level.</li> </ul>   | <b>56, 62</b>        |
| Playback does not follow the course of the disc's program.             | <ul style="list-style-type: none"> <li>It is in the mode of repeat playback, memory playback, etc.</li> </ul>   | <ul style="list-style-type: none"> <li>These operations may prevent a proper progress of the contents.</li> </ul>  | —                    |
| Buttons do not work.   | <ul style="list-style-type: none"> <li>Power supply fluctuations or other abnormalities such as static electricity may interrupt correct operations.</li> </ul> | <ul style="list-style-type: none"> <li>Press and hold the ON/STANDBY button on the front panel for more than about 3 seconds. The DVD player turns off. Press the button again to turn it on. If the buttons still do not work, disconnect the power plug and insert it into the wall outlet again.</li> </ul> | —                    |
| The remote control does not work properly.                             | <ul style="list-style-type: none"> <li>The remote control is not pointed at the remote sensor of the DVD player.</li> </ul>                                     | <ul style="list-style-type: none"> <li>Point the remote control at the remote sensor of the DVD player.</li> </ul>   | <b>15</b>            |
|  | <ul style="list-style-type: none"> <li>The remote control is too far from the DVD player.</li> </ul>  | <ul style="list-style-type: none"> <li>Operate the remote control within about 7 m.</li> </ul>   | <b>15</b>            |
|  | <ul style="list-style-type: none"> <li>The batteries in the remote control are exhausted.</li> </ul>  | <ul style="list-style-type: none"> <li>Replace the batteries with new ones.</li> </ul>   | <b>15</b>            |



## DVD player / outputs / supplied accessories

### DVD player

|                       |   |
|-----------------------|---|
| Power supply          | 120 V AC, 60 Hz   |
| Power consumption     | 16 W  |
| Mass                  | 2.5 kg  |
| External dimensions   | 430 × 69 × 219 mm (W/H/D)   |
| Signal system         | Standard NTSC   |
| Laser                 | Semiconductor laser, wavelength 650 nm / 780 nm                                     |
| Frequency range       | DVD linear sound : 48 kHz sampling 4 Hz to 22 kHz<br>96 kHz sampling 4 Hz to 44 kHz |
| Signal-to-noise ratio | More than 112 dB  |
| Audio dynamic range   | More than 108 dB  |
| Harmonic distortion   | Less than 0.002 %   |
| Wow and flutter       | Below measurable level (less than ±0.001 % (W.PEAK))                                |
| Operating conditions  | Temperature: 5 °C to 35 °C, Operation status: Horizontal                            |

### Outputs

|                                      |  |
|--------------------------------------|--|
| Video output                         | 1.0 V (p-p), 75 Ω, negative sync., pin jack × 1  |
| S video output                       | (Y) 1.0 V (p-p), 75 Ω, negative sync., Mini DIN 4-pin × 1<br>(C) 0.286 V (p-p), 75 Ω                                       |
| Component video output               | (Y) 1.0 V (p-p), 75 Ω, negative sync., pin jack × 1<br>(P <sub>B</sub> )/(P <sub>R</sub> ) 0.7 V (p-p), 75 Ω, pin jack × 2 |
| Audio output (BITSTREAM/PCM OPTICAL) | Optical connector × 1  |
| Audio output (BITSTREAM/PCM COAXIAL) | 0.5 V (p-p), 75 Ω, pin jack × 1  |
| Audio output (ANALOG AUDIO)          | 2.0 V (rms), 680 Ω, pin jacks (L, R) × 1   |

### Supplied Accessories

|                                 |   |
|---------------------------------|---|
| Audio/video cable .....         | 1 |
| Remote control (SE-R0070) ..... | 1 |
| Batteries (AAA) .....           | 2 |

- Designs and specifications are subject to change without notice.

## LIMITED WARRANTY DVD PLAYER

Toshiba America Consumer Products, Inc. ("TACP"), Toshiba Hawaii ("THI") and Toshiba Canada Limited ("TCL") make the following limited warranties. These limited warranties extend to original purchaser or any person receiving this set as a gift from the original purchaser and to no other purchaser or transferee.

### Limited Ninety (90) Day Warranty

TACP/THI warrant this product against defects in materials or workmanship for a period of ninety (90) days after the date of original retail purchase. During this period, TACP/THI will repair or replace a defective product or part, at their option, with a new or refurbished product or part without charge to you. You must deliver the entire product to a TACP/THI Authorized Service Station. You are responsible for all transportation and insurance charges for the unit to and from the Authorized Service Station. If you live in the U.S.A. you may, at your option, return your DVD Unit to:

Toshiba America Consumer Products Inc.  
Returns Center  
1420C Toshiba Dr.  
Lebanon, TN 37087

Upon receipt we will, at our option, exchange the DVD Unit with a new or refurbished unit. **Canadian consumers are requested to contact TCL. In Hawaii consumers are requested to contact THI.**

### Limited One (1) Year Warranty

TACP/THI further warrant the parts in this product against defects in materials or workmanship for a period of one (1) year after the date of original retail purchase. During this period, TACP/THI will repair or replace a defective product or part, at their option, with a new or refurbished product or part without charge to you, except that if a defective part is replaced after ninety (90) days from the date of the original retail purchase you pay labor charges involved in the replacement. You must also deliver the entire product to a TACP/THI Authorized Service Station. You are responsible for all transportation and insurance charges for the unit to and from the Authorized Service Station. If you live in the U.S.A. you may, at your option, return your DVD Unit to:

Toshiba America Consumer Products Inc.  
Returns Center  
1420C Toshiba Dr.  
Lebanon, TN 37087

Upon receipt we will, at our option, exchange the DVD Unit with a new or refurbished unit. **Canadian Consumers are requested to contact TCL. In Hawaii consumers are requested to contact THI.**

### Rental Units

The warranty for rental units begin with the first rental or thirty (30) days from the date of shipment to the rental firm, whichever comes first.

### Commercial Units

Products sold and used for commercial use have a limited ninety (90) day warranty for all parts and labor.

### Owner's Manual

You should read the owner's manual thoroughly before operating this product. You should complete and mail the enclosed Demographic card within ten (10) days after you, or the person who has given you this product as a gift, purchased this product. This is one way to enable TACP to provide you with better customer service and improved products. Failure to return the card will not affect your rights under this warranty.

### Your Responsibility

The above warranties are subject to the following conditions:

- (1) You must retain your bill of sale or provide other proof of purchase.
- (2) You must notify a TACP/THI/TCL /Authorized Service Station within thirty (30) days after you discover a defective product or part.
- (3) All warranty servicing of this product must be made by a TACP/THI/TCL Authorized Service Station.
- (4) U.S.A. warranties are effective only if the product is purchased and operated in the Continental U.S.A. or Puerto Rico.
- (5) Labor service charges for set installation. Set up, adjustment of customer controls and installation or repair of antenna systems are not covered by this warranty. Reception problems caused by inadequate antenna systems are your responsibility.
- (6) Warranties extend only to defects in materials or workmanship as limited above and do not extend to any product or parts which have been lost or discarded by you or to damage to products or parts caused by misuse, accident, damage caused by Acts of God, such as lighting or fluctuations in electric power, improper installation, improper maintenance or use in violation of instructions furnished by us; or to units which have been altered or modified without authorization of TACP/THI/TCL or to damage to products or part thereof which have had the serial number removed, altered, defaced or rendered illegible.
- (7) Should you elect to return your DVD Unit to TACP after the ninety (90) days and within one (1) year, or after the warranty period has expired: Call (800)-631-3811 to receive information concerning an exchange price. Payment must be enclosed with product in the form of a certified check or money order including reason for return.
- (8) Physically damaged DVD Units are not acceptable for repair or exchange whether in or out of warranty and will be returned as received.

## How to Obtain Warranty Service

- (1) Refer to the troubleshooting guide in your owner's manual. This check list may solve your problem.
- (2) In the U.S.A., only call the TACP toll free number 800-631-3811, or if in Hawaii or Canada see listing below within (30) days after you find a defective product or part.
- (3) Arrange for the delivery of the product to the TACP/THI/TCL Authorized Service Station or TACP Return Center. Products shipped to the Service Station must be insured and safely and securely packed, preferably in the original shipping carton, and a letter explaining the defect and also a copy of the bill of sale or other proof of purchase must be enclosed.

### In the Continental United States contact:



### In Hawaii contact:

Toshiba Hawaii Inc.  
327 Kamakee Street  
Honolulu, HA 96814  
(808)-521-5377

### In Canada contact:

Consumer Electronics Group  
191 McNabb Street  
Markham, Ontario L3R 8H2  
(905)-470-5400

Consumer Electronics Group  
22171 Fraserwood Way  
Richmond, B.C. V6W 1J5  
(604)-303-2500

Consumer Electronics Group  
1643 North Service Road  
Droval, QC H9P 1J1  
(514)-856-4100

All warranties implied by state law, including the implied warranties of merchantability and fitness for a particular purpose, are expressly limited to the duration of the limited warranties set forth above. With the exception of any warranties implied by state law as hereby limited, the foregoing warranty is exclusive and in lieu of all other warranties, guarantees, agreements and similar obligations of manufacturer or seller with respect to the repair or replacement of any parts. In no event shall TACP/THI be liable for consequential or incidental damages.

No person, agent, distributor, dealer or company is authorized to change, modify or extend the terms of these warranties in any manner whatsoever. The time within which an action must be commenced to enforce any obligation of TACP/THI arising under the warranty or under any statute, or law of the United States or any state thereof, is hereby limited to ninety (90) days from the date you discover or should have discovered, the defect. This limitation does not apply to implied warranties arising under state law.

This warranty gives you specific legal rights and you may also have other rights which may vary from state to state. Some states do not allow limitation on how long an implied warranty lasts, when an action may be brought, or the exclusion or limitation of incidental or consequential damages, so the above provisions may not apply to you.

### ATTENTION CANADIAN CONSUMERS:

Canadian consumers are requested to complete the special Canadian "Warranty Registration Form" enclosed, and forward this completed form with a copy of bill of sale to TOSHIBA OF CANADA to "Register and Validate" their warranty. Product must be purchased from an Authorized Canadian Dealer. Products purchased in the U.S.A. and used in Canada are not covered by these warranties.

### IMPORTANT: PACKING AND SHIPPING INSTRUCTION

When you send the product to a Service Station, you must use the original carton box and packing material, then insert the original carton box containing the unit into another carton using more packing material.

**TOSHIBA**

Printed in China